

**(DE) ACHTUNG!**

Vor Beginn der Montagearbeiten lesen Sie bitte aufmerksam die Sicherheitshinweise!

**(EN) WARNING!**

Before assembling, please read carefully the safety instructions!

**(NL) LET OP!**

Lees de veiligheidsinstructies zorgvuldig door voordat u met de montage begint!

**(FR) ATTENTION!**

Avant le début des travaux de montage, prière de lire attentivement les consignes de sécurité

**(IT) ATTENZIONE!**

Prima di installare leggere attentamente l'avviso di sicurezza!

**(ES) ATENCIÓN!**

Antes de comenzar con los trabajos de montaje leer detenidamente los avisos de seguridad!

**(PL) UWAGA!**

Przed przystąpieniem do prac montażowych uważnie należy przeczytać wskazówki bezpieczeństwa!

**(FI) HUOMIO!**

Ennen asennustöiden aloittamista pyydämme Teitä lukemaan turvaohjeet huolellisesti!

**(CZ) POZOR!**

Než začnete provádět montážní práce, přečtěte si důkladně bezpečnostní pokyny!

**(RU) ВНИМАНИЕ!**

До начала монтажных работ внимательно прочтите эти указания по технике безопасности!

**(GR) ΠΡΟΣΟΧΗ!**

Πριν την διεξαγωγή της συναρμολόγησης διαβάστε προσεκτικά τις υποδείξεις ασφαλείας!

**(RO) ATENȚIUNE!**

A se citi cu atenție indicațiile privind siguranța, înainte de începerea montării!

**(BG) ВНИМАНИЕ!**

Преди да започнете работите по монтажа прочетете внимателно указанията за безопасност!

**(TR) DİKKAT!**

Montaja başlamadan önce güvenlik talimatnamesini titizlikle okuyunuz!

**(HU) FLGYELEM!**

A szerelési munkák megkezdése előtt figyelmesen olvassa el a biztonsági útmutatásokat!

**(SV) OBS!**

Läs säkerhetsanvisningarna noga innan du börjar med monteringsarbetena!

**(HR) POZOR!**

Prije početka montaže molimo pozorno pročitajte sigurnosne naputke!

**(SL) POZOR!**

Prosim, da pred zacetkom montaze, zaradi varnosti preberete vas navodila, ki so prilozena!

**(SK) POZOR!**

Pred tým ako začnete robiť montážne práce, prečítajte si dôkladne bezpečnostné pokyny!

**(PT) CUIDADO!**

Antes de iniciar os trabalhos de montagem por favor leia atentamente os avisos de segurança!

**(BA) POZOR!**

Prije početka montaže molimo pažljivo pročitajte sigurnosne upute!

**(LT) DĖMESIO!**

Norėdami saugiai ir teisingai sumontuoti šviestuvą, vadovaukitės šia instrukcija!

**(ET) HOIATUS!**

Enne monteerimist lugege ohutusjuhised tähelepanelikult läbi!

**(DA) OBS!**

Læs sikkerhedsinformationen nøje, før du monterer produktet!

**(NO) ADVARSEL!**

Les sikkerhetsinformasjonen nøye før du monterer produktet!

**(LV) UZMANĪBU!**

Pirms montāžas uzmanīgi izlasiet drošības norādījumus!



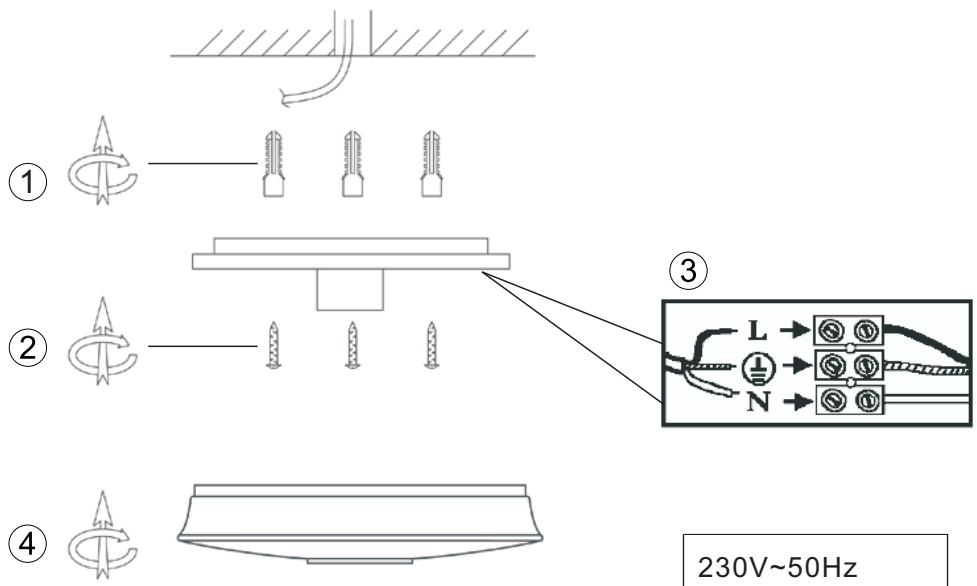

230V~50Hz  
1xLED10W+RGB

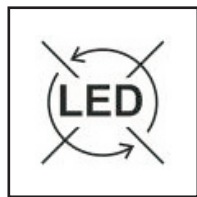
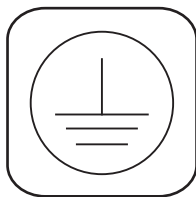
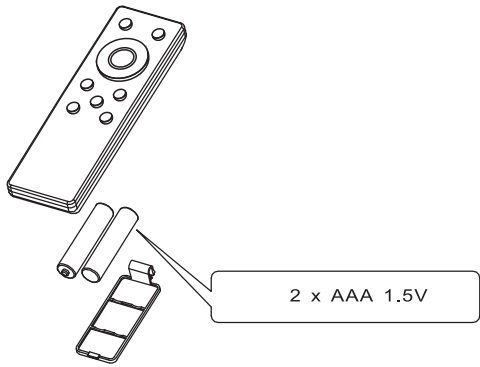

**IP 20**

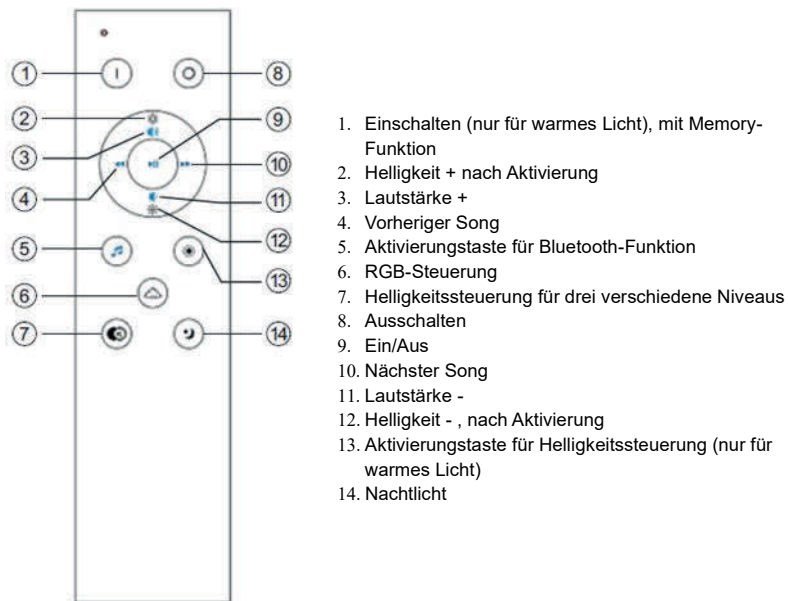









## Anweisungen:

### I. Beleuchtungssteuerung

1: Schalten Sie den Leistungsschalter (Netzschalter) der installierten Deckenlampe ein, und das warme Licht der Deckenlampe leuchtet auf (warmes Licht).

2: Zu diesem Zeitpunkt können Sie die Fernbedienung zur Einstellung der Helligkeit der Hauptleuchte (warmes Licht) und der Farbe der RGB verwenden. Die Bedienung funktioniert folgendermaßen:

-  Warmes Licht einschalten. Es merkt sich die Helligkeit, mit der die Leuchte das letzte Mal ausgeschaltet wurde. RGB und Nachtlicht haben keine Memory-Funktion;
-  Licht ausschalten (warmes Licht und RGB-Licht beide aus)
-  Aufdimmen, Helligkeit des warmen Lichts erhöhen
-  Abdimmen, Helligkeit des warmen Lichts vermindern
-  Aktivieren der Lichtsteuerungsfunktion (nur wenn Sie diese Taste zuerst drücken, können Sie Auf- und Abdimmen auf der mittleren Navigationstaste nutzen, um  die Helligkeit des warmen Lichts anzupassen;)
-  RGB-Modusumschalter. 5 Modi: (1). Rotes Licht; (2). Grünes Licht; (3). Blaues Licht; (4). 7-Farben-Licht mit allmählicher Änderung; (5). 7-Farben-Licht mit plötzlicher Änderung;
-  3-Niveau-Helligkeit, 35 %--68 %---100 %
-  Nachtlicht

## II. Musiksteuerung

1: Schalten Sie den Leistungsschalter (Netzschalter) der installierten Deckenlampe ein, und das warme Licht der Deckenlampe leuchtet auf. (warmes Licht)

2: Koppeln Sie mit Bluetooth

(1). Rufen Sie die Schnittstelle Einstellungen des Smartphones auf.

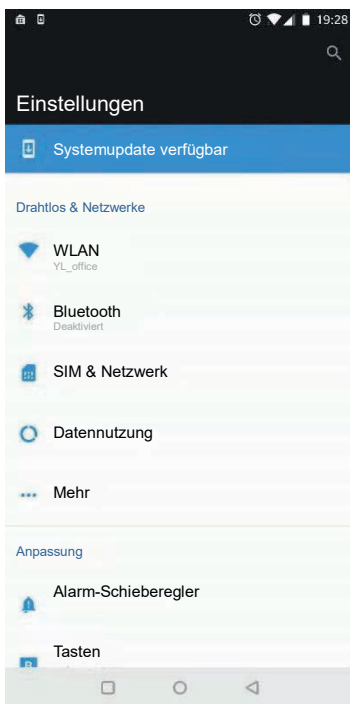

(2). Auf Bluetooth klicken, um die Bluetooth-Funktion Ihres Telefons zu aktivieren.



(3). Auf Koppeln des neuen Gerätes klicken; das Smartphone sucht nach einem neuen Bluetooth-Gerät in Reichweite. Suche nach „BSD-BT“, zum Koppeln klicken. Wenn Sie einen Piepton hören, ist die Koppelung abgeschlossen.

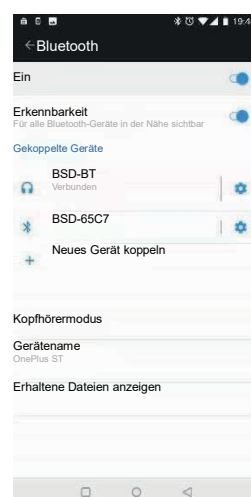
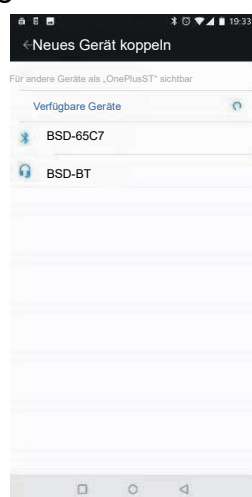
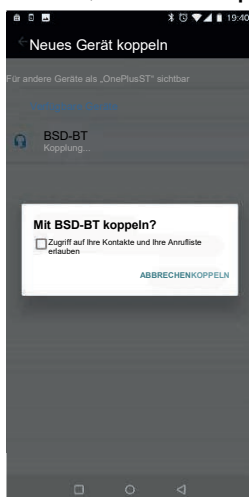

3: Öffnen Sie nach Abschluss der Koppelung den Musikplayer des Mobiltelefons, um die Musik abzuspielen. Bei der Musikwiedergabe kann die Fernsteuerung zum Steuern des Bluetooth genutzt werden. Die Bedienung funktioniert wie folgt:

 Lautstärke +

 Lautstärke -

 Vorheriger Song

 Nächster Song

 Abspielen/Pause; diese Taste funktioniert, wenn die Bluetooth-Verbindung mit dem Smartphone und Music Lights erfolgreich ist.

 Aktivieren der Lichtsteuerungsfunktion (nur wenn Sie diese Taste zuerst drücken, können Sie Lautstärke + , Lautstärke - , Vorheriger Song und

Nächster Song auf der mittleren Navigationstaste nutzen, um  die Musik zu wechseln.

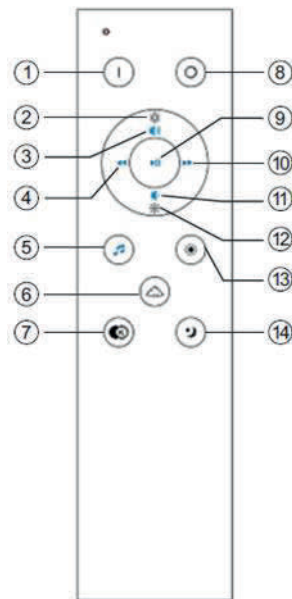









1. Turn on (only for warm light), with memory function
2. Brightness + after being activated
3. Volume +
4. Previous song
5. Activate button for Bluetooth function
6. RGB control
7. Brightness control for three different levels
8. Turn off
9. On/Off
10. Next song
11. Volume -
12. Brightness - , after being activated
13. Activate button for brightness control (only for warm light)
14. Night light

## Instructions:

### I. Lighting control

1: Turn on the power switch (AC power switch) of the installed ceiling light, and the warm light of the ceiling light will light up (warm light).

2: At this time, you can use the remote control to adjust the brightness of the main light (warm light) and the colour of the RGB. The operation is as follows:

-  Turn on the warm light, remember the brightness when the light was turned off last time, RGB and night light have no memory function
-  Turn off the light (warm light and RGB light both off)
-  Dim up, increase the brightness of the warm light
-  Dim down, decrease the brightness of the warm light
-  Activate the light control function (only when you press this key first, you can use the dim up and dim down on the middle navigation key to adjust  the brightness of the warm light;)
-  RGB mode switching. 5 modes: (1). Red light; (2). Green light; (3). Blue light; (4). 7-colour light gradual change; (5).7-colour light sudden change;
-  3-level brightness, 35%--68%---100%
-  Night light

### II. Music control

1: Turn on the power switch (AC power switch) of the installed ceiling light, and the warm light of the ceiling light will light up. (warm light)

## 2: Pair the Bluetooth

### (1). Enter the smart phone's settings interface

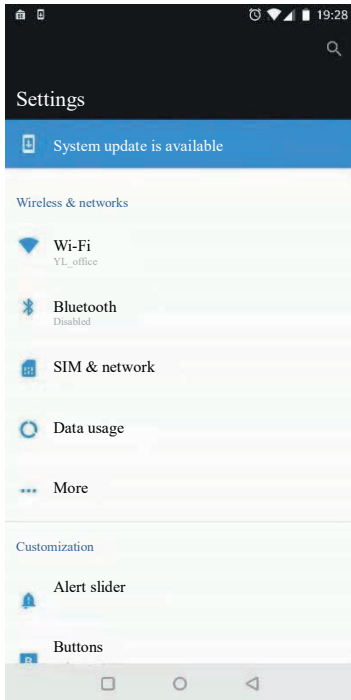

### (2). Click Bluetooth to turn on the Bluetooth function of your phone

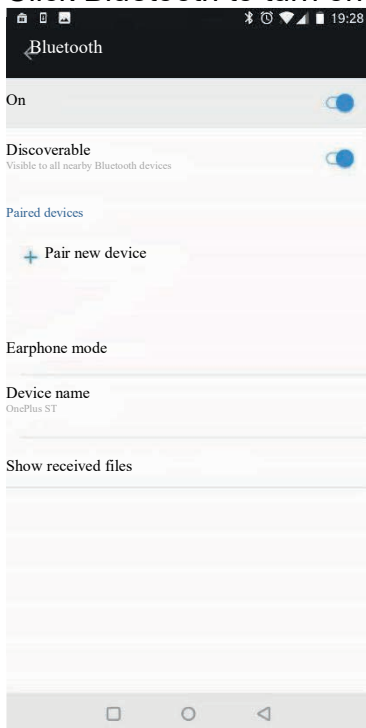



(3). Click pairing the new device; the smart phone starts to search for a new Bluetooth device in range. Searching for “BSD-BT”, click to pair. When you hear a beep tone, the pairing is successful.

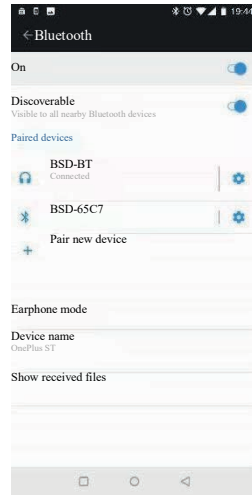
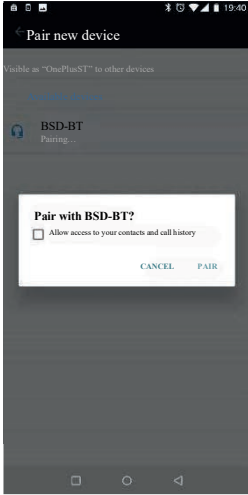

3: After the pairing is successful, open the music player in the mobile phone to play the music. While playing music the remote control can be used to control the Bluetooth. Operation as follow:

 Volume +

 Volume -

 Previous song

 Next song

 Play/Pause; this key works when the Bluetooth connecting with the smart phone and music lights is successful.

 Activate the light control function ,(only when you press this key first, you can use the Volume + , Volume - , Previous song and Next song on the

middle navigation key  to change the music.

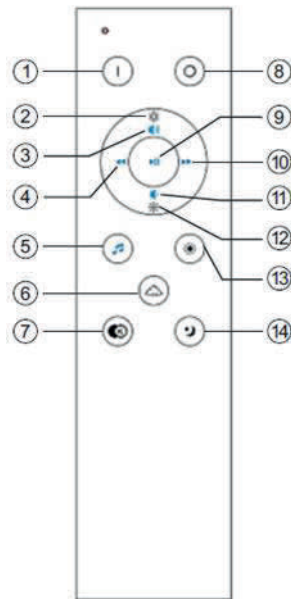

1. Encender (solo para luz cálida), cuenta con función memoria
2. Brillo + después de activarlo
3. Volumen +
4. Canción anterior
5. Activar el botón para función Bluetooth
6. Control de RGB
7. Control de brillo para tres niveles diferentes
8. Apagar
9. Encendido/Apagado
10.       Siguiente canción
11.       Volumen -
12.       Brillo -, después de activarlo
13.       Activar el botón para control de brillo (solo para luz cálida)
14.       Luz nocturna

## Instrucciones:

### I. Control de la iluminación

1: Encienda el interruptor de energía (interruptor de energía de CA) de la lámpara de techo instalada y se encenderá la luz cálida de la lámpara de techo (luz cálida).

2: A partir de este momento, puede usar el control remoto para ajustar el brillo de la luz principal (luz cálida) y el color de la RGB. La operación se realiza de la siguiente manera:

 Encender la luz cálida, recuerda el brillo de la última vez que se apagó la lámpara, la luz RGB y la luz nocturna no tienen función de memoria

 Apagar la lámpara (se apagarán la luz cálida y la luz RGB)

 Aumentar la intensidad, aumenta el brillo de la luz cálida

 Disminuir la intensidad, atenúa el brillo de la luz cálida

 Activar la función de control de la luz (solo si oprime esta tecla en primer lugar, puede usar la tecla de navegación que se encuentra en el centro para aumentar o atenuar la intensidad a fin

de ajustar  el brillo de la luz cálida);

 Cambiar el modo de RGB. 5 modos: (1). Luz roja; (2). Luz verde; (3). Luz azul; (4). Cambio gradual de la luz en 7 colores; (5). cambio súbito de la luz en 7 colores;

 3 niveles de brillo, 35%--68%---100%

 Luz nocturna

## II. Control de la música

1: Encienda el interruptor de energía (interruptor de energía de CA) de la lámpara de techo instalada y se encenderá la luz cálida de la lámpara de techo. (luz cálida).

2: Emparejar el Bluetooth

(1). Entre en la interfaz de configuración del teléfono inteligente.

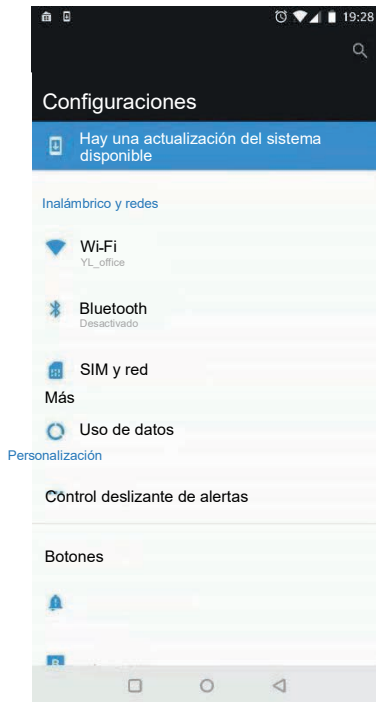

(2). Haga clic en Bluetooth para encender la función de Bluetooth de su teléfono.

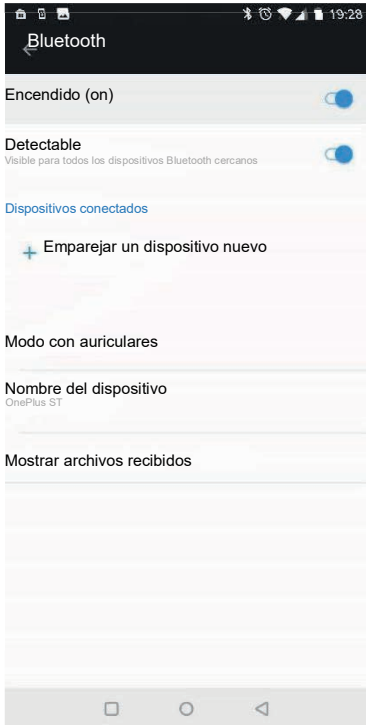

(3). Haga clic para emparejar el dispositivo nuevo; el smartphone comienza a buscar un nuevo dispositivo Bluetooth que esté dentro del rango. Buscando “BSD-BT”, haga clic para conectar. Cuando oiga un pitido, el emparejamiento se habrá realizado correctamente.

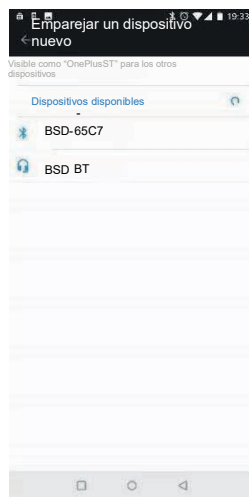



3: Después de realizar el emparejamiento correctamente, abra el reproductor de música del teléfono móvil para reproducir la música. Mientras se reproduce música, se puede usar el control remoto para controlar el Bluetooth. La operación se realiza de la siguiente manera:

 Volumen +

 Volumen -

 Canción anterior

 Siguiente canción

 Reproducir/Pausa; esta tecla funciona cuando la conexión por Bluetooth con el teléfono inteligente y las luces musicales se haya realizado correctamente.

 Activar la función de control de la luz , (solo si pulsa esta tecla en primer lugar, puede usar Volumen + , Volumen - , Canción anterior y Siguiente canción mediante la tecla de navegación que se encuentra en el centro



para cambiar la música.

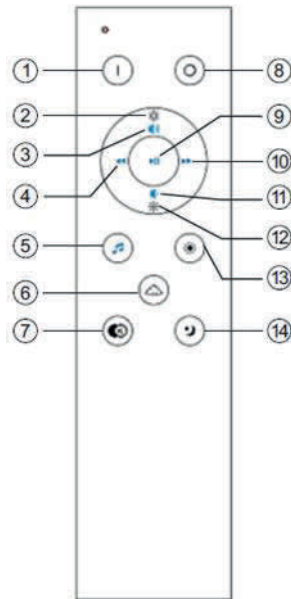









1. Accendere (solo per luce calda), con funzione di memoria
2. Luminosità + dopo essere stato attivato
3. Volume +
4. Brano precedente
5. Tasto di attivazione per la funzione Bluetooth
6. Controllo RGB
7. Controllo della luminosità in tre diversi livelli
8. Spegner
9. On/Off
10. Brano successivo
11. Volume -
12. Luminosità -, dopo essere stato attivato
13. Tasto di attivazione per il controllo della luminosità (solo per luce calda)
14. Luce notturna

## Istruzioni:

### I. Controllo dell'illuminazione

1: Accendere l'interruttore (interruttore di alimentazione CA) della lampada da soffitto installata e la luce calda della lampada da soffitto si accenderà (luce calda).

2: A questo punto, si può utilizzare il telecomando per regolare la luminosità della luce principale (luce calda) e il colore dell'RGB. L'operazione è la seguente:

-  Accendere la luce calda ricordando la luminosità della luce quando è stata spenta l'ultima volta, l'RGB e la luce notturna non hanno la funzione di memoria;
-  Spegner la luce (luce calda e luce RGB entrambe spente)
-  Illuminare, aumentare la luminosità della luce calda
-  Affievolire la luce, diminuire la luminosità della luce calda
-  Attivare la funzione di controllo della luce (solo dopo aver premuto questo tasto, è possibile utilizzare le funzioni per aumentare e diminuire l'illuminazione del tasto di navigazione centrale per regolare  la luminosità della luce calda; Modalità di commutazione RGB. 5 modalità: (1). Luce rossa; (2). Luce verde; (3). Luce blu; (4). Cambiamento graduale della luce in 7 colori; (5) cambiamento improvviso della luce in 7 colori;
-  Cambiamento graduale della luce in 7 colori; (5) cambiamento improvviso della luce in 7 colori;
-  Luminosità a 3 livelli, 35%--68%---100%
-  Luce notturna;

### II. Controllo della musica

1: Accendere l'interruttore (interruttore di alimentazione CA) della lampada da soffitto installata e la luce calda della lampada da soffitto si illuminerà. (luce calda).

## 2: Associare il Bluetooth

(1). Accedere all'interfaccia delle impostazioni dello smartphone.

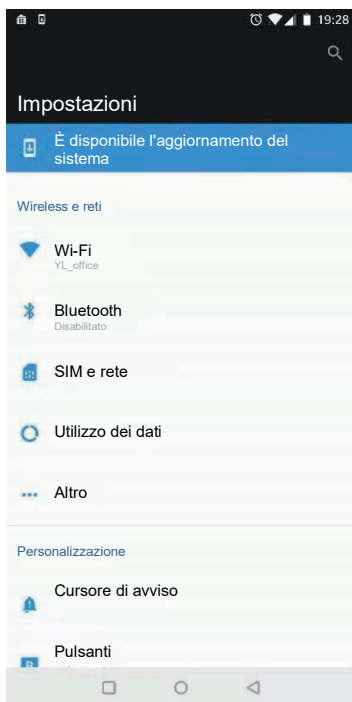

(2). Fai clic su Bluetooth per attivare la funzione Bluetooth del tuo telefono.

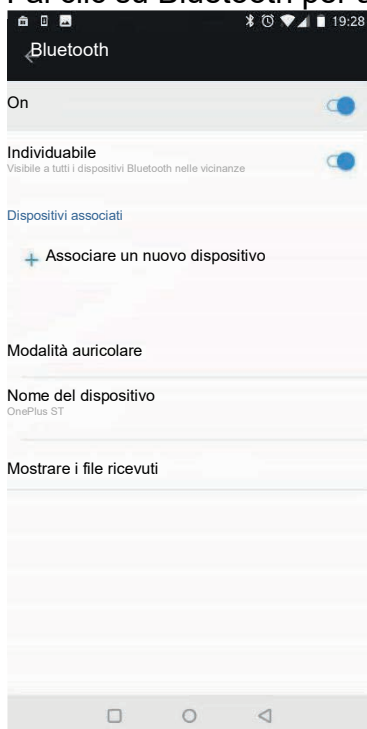

- (3). Fare clic su Associare un nuovo dispositivo; lo smartphone inizia a cercare un nuovo dispositivo Bluetooth nel suo raggio d'azione. Ricercare "BSD-BT", fare clic per associare. Quando si sente un segnale acustico, il processo di associazione è andato a buon fine.

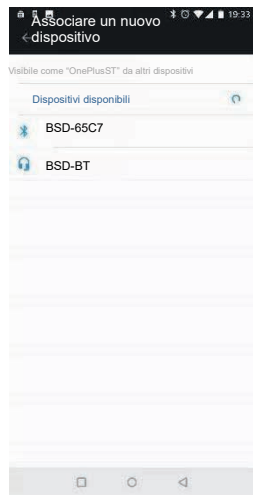



- 3: Dopo che il processo di associazione è andato a buon fine, aprire il lettore musicale nel telefono cellulare per riprodurre la musica. Durante la riproduzione della musica è possibile utilizzare il telecomando per controllare il Bluetooth. Funziona nel modo seguente:

 Volume +

 Volume -

 Brano precedente

 Brano successivo

 Play/Pause; questo tasto funziona quando la connessione Bluetooth con lo smartphone e le luci della musica è stata effettuata con successo.

 Attivare la funzione di controllo della luce, (solo dopo aver premuto questo tasto si può usare le funzioni Volume +, Volume -, Brano precedente e

Brano successivo del tasto di navigazione centrale  per cambiare la musica.



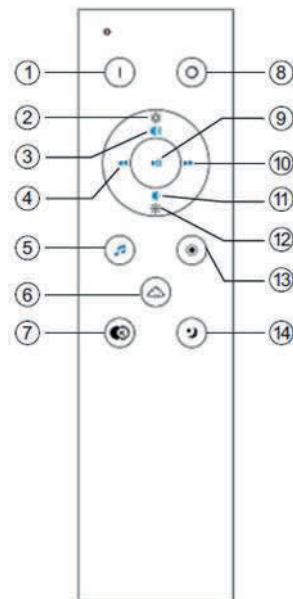

1. Allumage (uniquement pour lumière chaude), avec fonction mémoire
2. Luminosité +, après activation
3. Volume +
4. Chanson précédente
5. Activer la touche pour la fonction Bluetooth
6. Contrôle RVB
7. Réglage de la luminosité pour trois niveaux différents
8. Éteindre
9. On/Off
10. Chanson suivante
11. Volume -
12. Luminosité -, après activation
13. Activer la touche pour le contrôle de la luminosité (uniquement pour la lumière chaude)
14. Veilleuse

## Instructions :

### I. Contrôle de l'éclairage

1: Allumez l'interrupteur d'alimentation (interrupteur d'alimentation AC) du plafonnier installé, et la lumière du plafonnier s'allumera (lumière chaude).

2: À ce moment, vous pouvez utiliser la télécommande pour régler la luminosité (lumière chaude) et la couleur RVB de l'éclairage principal. Procédez comme suit :



 Allumez la lumière chaude, souvenez-vous de la luminosité lorsque la lumière a été éteinte la dernière fois, le RVB et la veilleuse n'ont pas de fonction mémoire

 Éteignez la lumière (lumière chaude et lumière RVB éteintes)

 Augmentez la luminosité de la lumière chaude

 Réduisez la luminosité de la lumière chaude

Activez la fonction de contrôle de l'éclairage (seulement si vous appuyez d'abord sur cette

 touche, vous pouvez utiliser les touches de navigation du milieu pour régler  la luminosité de la lumière chaude)

 Commutation en mode RVB. 5 modes : (1) Lumière rouge ; (2) Lumière verte ; (3) Lumière bleue ; (4) Changement graduel de la lumière en 7 couleurs ; (5) Changement soudain de la lumière en 7 couleurs ;

 3 niveaux de luminosité, 35 %--68 %---100 %

 Veilleuse

### II. Contrôle de la musique

1: Allumez l'interrupteur d'alimentation (interrupteur d'alimentation AC) du plafonnier installé, et la lumière du plafonnier s'allumera (lumière chaude).

2: Apparez le Bluetooth de votre smartphone  
(1). Allez dans Paramètres.

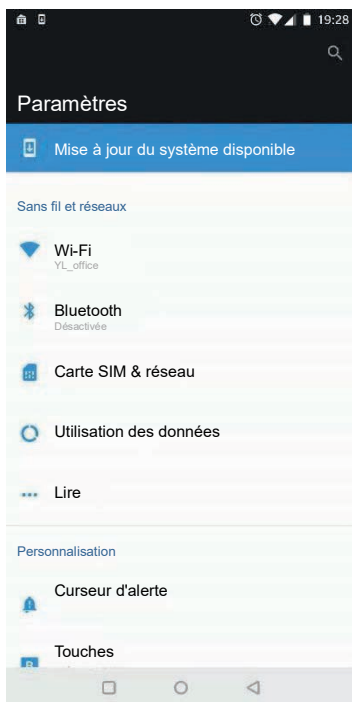

(2). Tapotez sur Bluetooth pour activer la fonction Bluetooth de votre smartphone.

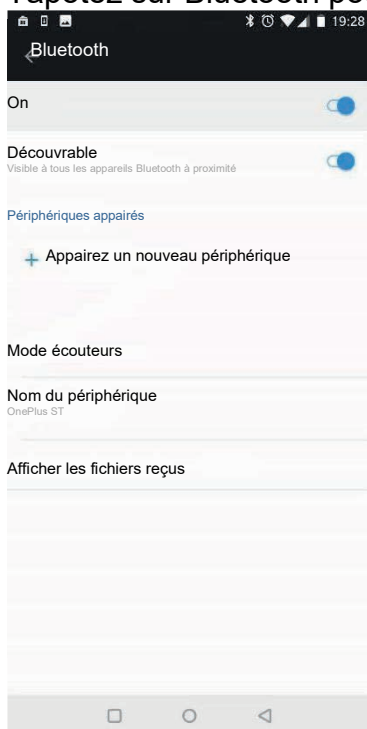

(3). Tapotez sur « Appairez un nouveau périphérique » ; le smartphone commence à rechercher un nouveau périphérique Bluetooth à proximité. Recherche de "BSD-BT", cliquez pour appairer. Lorsque vous entendez un bip sonore, l'appairement s'est effectué avec succès.

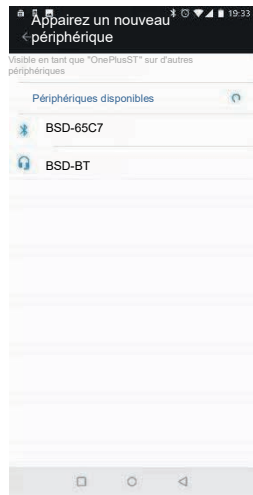

3: Une fois l'appairage réussi, ouvrez le lecteur de musique sur le smartphone pour écouter la musique. Pendant que vous écoutez de la musique, la télécommande peut être utilisée pour contrôler le Bluetooth. Procédez comme suit :

 Volume +

 Volume -

 Titre précédent

 Titre suivant

 Lecture/Pause ; cette touche fonctionne lorsque la connexion Bluetooth avec le smartphone s'est effectuée avec succès.

 Activer la fonction de commande de l'éclairage (uniquement si vous appuyez d'abord sur cette touche, vous pouvez utiliser les options Volume + , Volume - , Titre précédent et Titre suivant sur la touche de navigation

centrale  pour changer la musique.

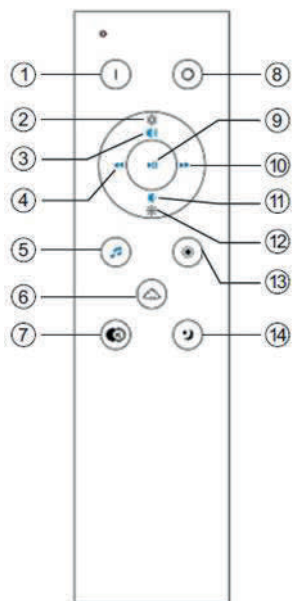









15. Включване (само за топла светлина) с функция за памятване
16. Яркост + след активиране
17. Сила на звука +
18. Предишна песен
19. Бутон за активиране на Bluetooth функция
20. Контрол на цветовете червен/зелен/син (RGB)
21. Контрол на яркостта с три различни нива
22. Изключване
23. Включване/Изключване
24. Следваща песен
25. Сила на звука -
26. Яркост - , след активиране
27. Активиране на бутона за контрол на яркостта (само за топла светлина)
28. Нощно осветление

## Инструкции:

### I. Управление на осветлението

1: Включете захранването (ключ за захранване с променлив ток) на инсталираната на таванно осветително тяло и тя ще заработи в режим топла светлина (топла светлина).

2: Вече можете да използвате дистанционното управление за настройка на яркостта на основното осветление (топла светлина) и цветовете - RGB. Операцията се извършва по следния начин:

-  Включете топлата светлина, след като сте запомнили силата на яркост при последното изключване на осветлението, тъй като функциите RGB и нощно осветление не се запаметяват
-  Изключете осветлението (функциите RGB и топла светлина са изключени)
-  Усилете димирането, за да увеличите яркостта на топлата светлина
-  Снизете димирането, за да намалите яркостта на топлата светлина
-  Активирайте функцията за управление на осветлението (само когато натиснете първо този бутон ще можете да увеличавате и снижавате димирането със средния бутон за навигация, за да регулирате  яркостта на топлата светлина;)
-  Превключване на режими RGB. 5 режими: (1). Червена светлина; (2). Зелена светлина; (3). Синя светлина; (4). 7 цвята с последователна смяна; (5). 7 цвята със случайна смяна;
-  3 нива на яркост: 35% - 68% - 100%
-  Нощно осветление

## II. Контрол на музиката

1: Включете захранването (ключ за захранване с променлив ток) на инсталираната на таванно осветително тяло и то ще заработи в режим топла светлина (топла светлина).

2: Сдвояване с Bluetooth

(1). Влезте в настройките на смартфона.

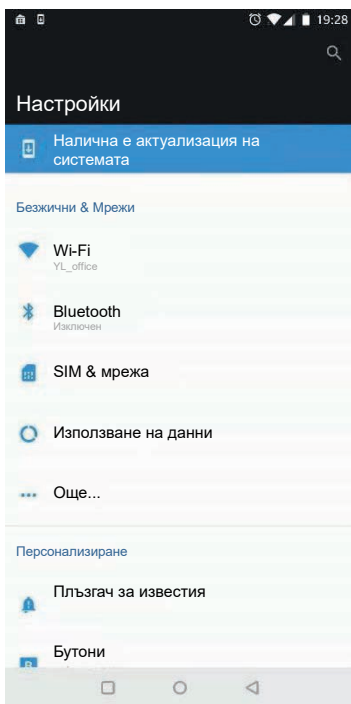

(2). Докоснете Bluetooth, за да включите функцията Bluetooth на телефона.

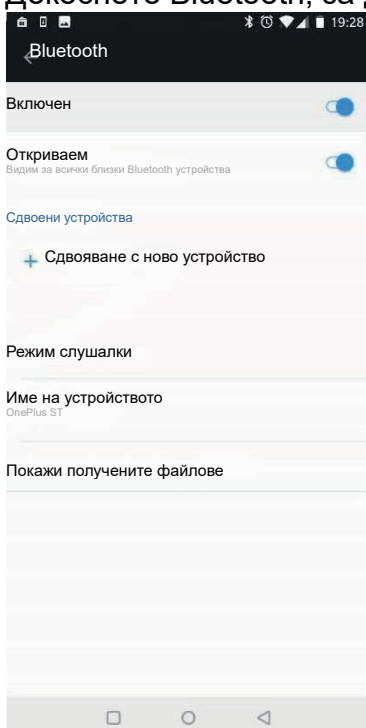

(3). Докоснете „Сдвояване с ново устройство“, смартфонът ще започне да търси нови Bluetooth устройства в обхвата. Търсете “BSD-BT”, докоснете за сдвояване. Когато чуете звук сигнал,сдвояването е успешно.

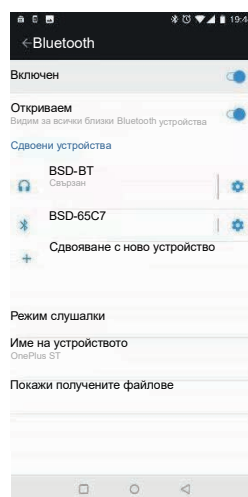
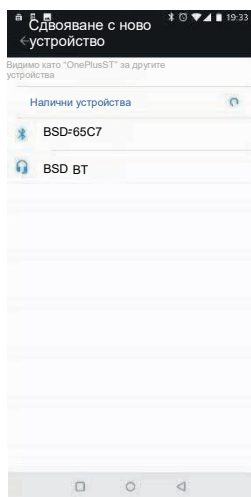
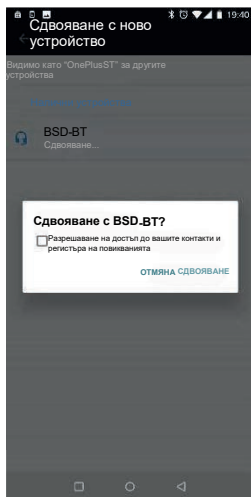

3: След като сдвояването приключи успешно, отворете музикалния плейър на мобилния телефон за прослушване на музиката. Докато се прослушва музиката дистанционното управление може да се използва за контрол с Bluetooth. Операциите са следните:



Сила на звука +



Сила на звука -



Предишна песен



Следваща песен



Възпроизвеждане /Пауза - този бутон работи когато е установена успешна Bluetooth връзка на телефона с музикалното осветително тяло.



Активирайте функцията за контрол на осветлението (само когато натиснете първо този бутон ще можете да използвате Сила на звука +, Сила на звука -, Предишна песен и Следваща песен на средния бутон

за навигация  , за да променят музиката.

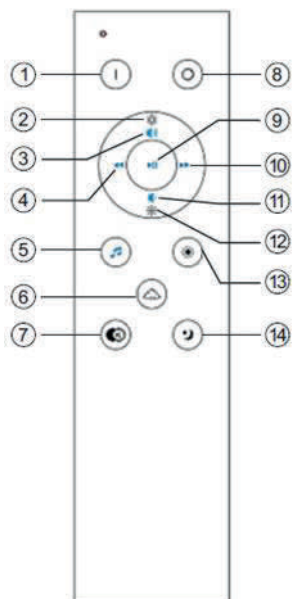









1. Uključi (samo za toplo svjetlo), sa funkcijom pamćenja
2. Jačina osvjetljenja + nakon što je aktivirano
3. Pojačavanje +
4. Prethodna pjesma
5. Pritisnite dugme za funkciju Bluetooth
6. RGB kontrola
7. Kontrola jačine osvjetljenja za tri različita nivoa
8. Isključi
9. Uključeno/Isključeno
10. Sljedeća pjesma
11. Utišavanje -
12. Jačina osvjetljenja - , nakon što je aktivirano
13. Pritisnite dugme za kontrolu jačine osvjetljenja (samo za toplo svjetlo)
14. Noćno svjetlo

## Uputstva:

### I. Kontrola osvjetljenja

1: Uključite prekidač za paljenje (AC prekidač) na postavljenoj plafonjeri i upaliće se toplo svjetlo plafonjere (toplo svjetlo).

2: U ovom trenutku možete da koristite daljinski upravljač da podesite jačinu glavnog svjetla (toplo svjetlo) i boju iz RGB spektra. Upravlja se na sljedeći način:

-  Upalite toplo svjetlo, zapamtite jačinu osvjetljenja kada je svjetlo bilo posljednji put ugašeno, RGB i noćno svjetlo nemaju funkciju pamćenja
-  Isključite svjetlo (isključiće se i toplo i RGB svjetlo)
-  Pojačavanje svjetla, povećajte jačinu osvjetljenja toplog svjetla
-  Prigušivanje svjetla, smanjite jačinu osvjetljenja toplog svjetla
- Aktivirajte funkciju kontrole svjetla (tek kada prvo pritisnete ovu tipku možete da pojačavate ili prigušite preko navigacione tipke u sredini kako biste podesili  jačinu osvjetljenja toplog svjetla;)
-  Prebacivanje RGB načina rada. 5 načina rada: (1). Crveno svjetlo; (2). Zeleno svjetlo; (3). Plavo svjetlo; (4). Postepena promjena 7 različitih boja; (5). Nagla promjena 7 različitih boja;
-  3 nivoa osvjetljenosti, 35%--68%---100%
-  Noćno svjetlo

### II. Kontrola muzike

1: Uključite prekidač za paljenje (AC prekidač) na postavljenoj plafonjeri i upaliće se toplo svjetlo plafonjere. (toplo svjetlo)

## 2: Povežite preko Bluetootha

(1). Uđite u sučelje za podešavanja na pametnom telefonu.

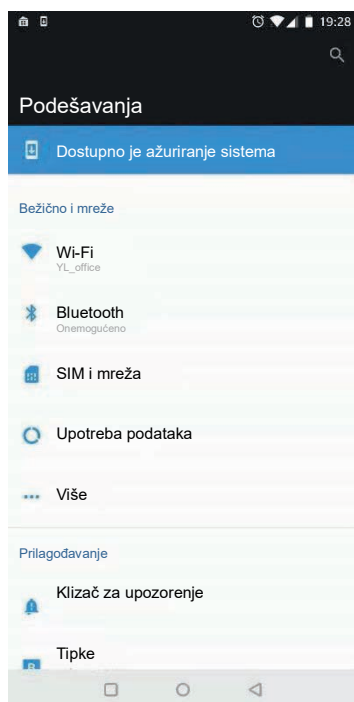

(2). Pritisnite Bluetooth da uključite funkciju Bluetooth na Vašem telefonu.

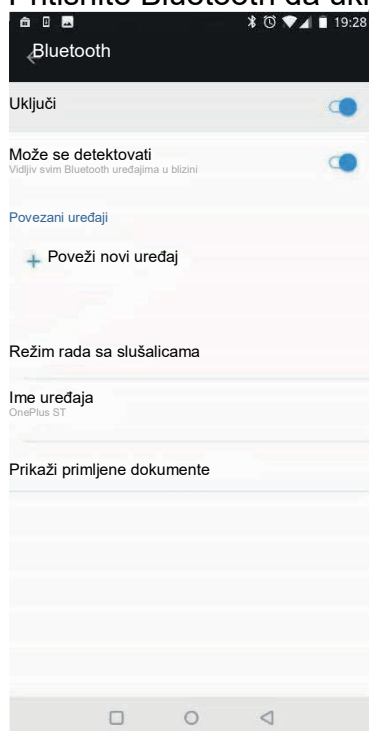



(3). Pritisnite povezivanje novog uređaja; pametni telefon počinje da traži novi Bluetooth uređaj u blizini. Pretražujem "BSD-BT", pritisni da povežeš. Kada čujete ton, povezivanje je uspješno.

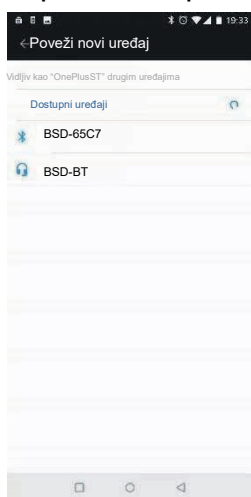

3: Nakon što je povezivanje uspelo, otvorite aplikaciju za puštanje muzike na mobilnom telefonu kako biste pustili muziku. Dok puštate muziku, možete da koristite daljinski upravljač da kontrolirate Bluetooth. Upravlja se na sljedeći način:

 Pojačavanje +

 Utišavanje -

 Prethodna pjesma

 Sljedeća pjesma

 Pusti/Zaustavi; ova tipka radi kada su povezivanje Bluetootha sa pametnim telefonom i muzičkim svjetlima .

 Aktivirajte funkciju kontrole svjetla (tek kada prvo pritisnete ovu tipku možete da koristite Pojačaj + ili Utišaj - , Prethodna pjesma i Sljedeća

pjesma preko navigacione tipke u sredini  kako biste promijenili muziku.

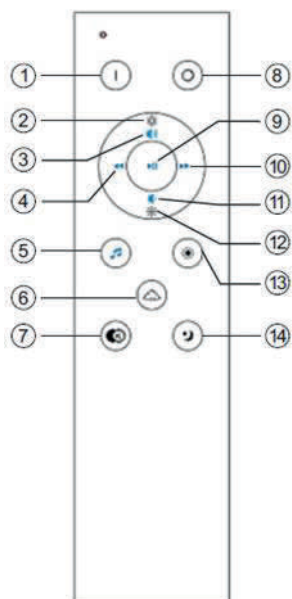









1. Zapnutí (pouze pro teplé světlo), s funkcí paměti
2. Jas +, po aktivaci
3. Hlasitost +
4. Předchozí skladba
5. Tlačítko pro aktivaci funkce Bluetooth
6. Ovládání RGB
7. Ovládání jasu, tři různé úrovně
8. Vypnutí
9. Zap/vyp
10. Další skladba
11. Hlasitost -
12. Jas -, po aktivaci
13. Tlačítko pro aktivaci ovládání jasu (pouze pro teplé světlo)
14. Noční světlo

## Pokyny:

### I. Ovládání světla

1: Zapněte vypínač (síťový vypínač) na nainstalovaném stropním světle, na rozsvítí se na něm teplé světlo (teplé světlo).

2: V tuto chvíli můžete pomocí dálkového ovládání upravit jas hlavního světla (teplé světlo) a barvu RGB. Ovládání je následující:

-  Rozsvítí teplé světlo, zařízení si zapamatuje jas v okamžiku posledního vypnutí světla, RGB a noční světlo funkci paměti nemají.
-  Zhasne světlo (zhasne teplé světlo i RGB).
-  Zvýší jas teplého světla.
-  Sniží jas teplého světla.
-  Aktivuje funkci ovládání světla (funkci zvyšování a snižování jasu teplého světla uprostřed navigačního tlačítka  budete moci použít, pouze pokud nejprve stisknete toto tlačítko).
-  Přepínání režimu RGB. 5 režimy: (1). červené světlo; (2). zelené světlo; (3). modré světlo; (4). postupná změna 7 barev světla; (5). náhlá změna 7 barev světla.
-  3 úrovně jasu, 35 % -- 68 % --- 100 %.
-  Noční světlo.

### II. Ovládání hudby

1: Zapněte vypínač (síťový vypínač) na nainstalovaném stropním světle, na rozsvítí se na něm teplé světlo (teplé světlo).

## 2: Spárujte Bluetooth.

(1). Přejděte do rozhraní nastavení chytrého telefonu.

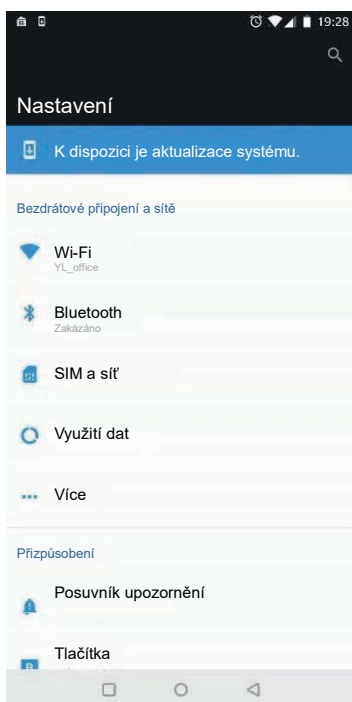

(2). Klikněte na možnost Bluetooth, abyste na telefonu zapnuli funkci Bluetooth.

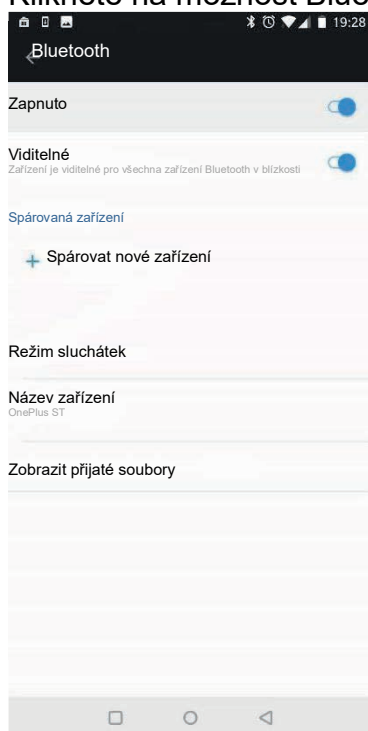

- (3). Klikněte na možnost pro párování s novým zařízením; chytrý telefon začne vyhledávat nová zařízení Bluetooth ve svém dosahu. Vyhledejte zařízení „BSD-BT“, kliknutím zařízení spárujte. Až se ozve pípnutí, bylo párování úspěšně dokončeno.

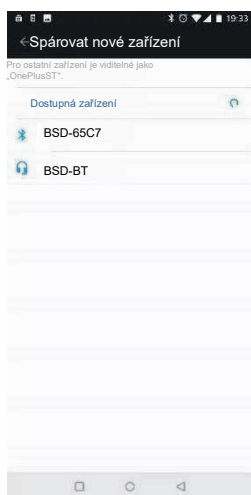
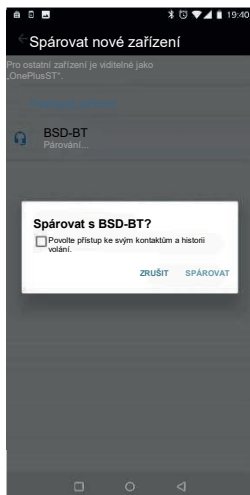

- 3: Po úspěšném dokončení párování otevřete v mobilním telefonu hudební přehrávač a spusťte přehrávání hudby. Během přehrávání hudby můžete pomocí dálkového ovládání ovládat funkce Bluetooth. Ovládání je následující:

 Hlasitost +

 Hlasitost -

 Předchozí skladba

 Další skladba

 Spustit/pozastavit přehrávání; toto tlačítko funguje, když bylo připojení Bluetooth mezi chytrým telefonem a hudebním světlem úspěšné.

 Aktivuje funkci ovládání světla (funkce hlasitost +, hlasitost -, předchozí

skladba a další skladba uprostřed navigačního tlačítka  budete moci ke změně přehrávání hudby použít, pouze pokud nejprve stisknete toto tlačítko).

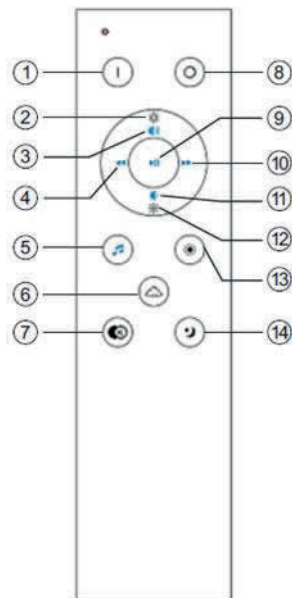









1. Tænd (kun for varmt lys), med hukommelsesfunktion
2. Lysstyrke + efter aktivering
3. Lydstyrke +
4. Forrige nummer
5. Aktivér knap til Bluetooth-funktion
6. RGB-kontrol
7. Lysstyrke-kontrol til tre forskellige niveauer
8. Slå fra
9. Til/Fra
10. Næste nummer
11. Lydstyrke -
12. Lysstyrke - efter aktivering
13. Aktivér knap for lysstyrke-kontrol (kun for varmt lys)
14. Natbelysning

## Instruktioner:

### I. Lyskontrol

1: Tænd for strømafbryderen (vekselstrømsafbryderen) på det installerede loftsls, og det varme lys i loftet tændes (varmt lys).

2: På dette tidspunkt kan du bruge fjernbetjeningen til at justere lysstyrken for hovedlyset (varmt lys) og farven på RGB. Betjeningen er som følger:

-  Tænd det varme lys, husk lysstyrken da lyset blev slukket sidste gang, RGB og natlys har ingen hukommelsesfunktion
-  Sluk lyset (varmt lys og RGB-lys begge slukket)
-  Øg lysstyrken, øg lysstyrken for det varme lys
-  Sænk lysstyrken, sænk lysstyrken for det varme lys
-  Aktivér lyskontrol-funktionen ,(kun hvis du trykker på denne knap først, kan du bruge dæmpning og øgning af lys på den midterste navigationsknap, til at justere  lysstyrken for det varme lys;)
-  RGB-tilstand skift. 5 tilstande: (1). Rødt lys; (2). Grønt lys; (3). Blåt lys; (4). 7-farvet lys gradueret ændring; (5).7-farvet lys, pludselig ændring
-  3-trins lysstyrke, 35%--68%---100%
-  Natbelysning

### II. Musikkontrol

1: Tænd for strømafbryderen (vekselstrømsafbryderen) på det installerede loftsls, og det varme lys i loftet tændes (varmt lys)

## 2: Par Bluetooth

(1). Gå til smartphonens interface for indstillinger.

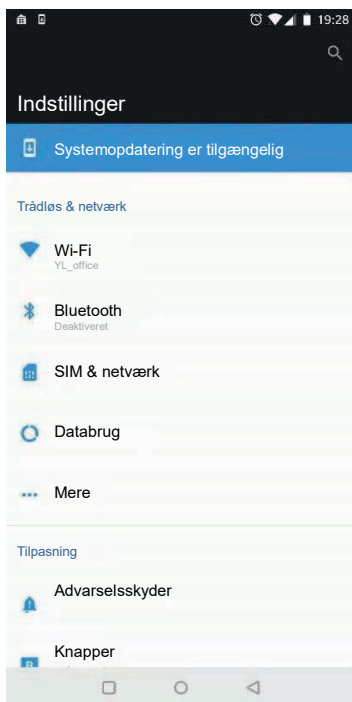

(2). Klik på Bluetooth, for at tænde Bluetooth-funktionen på din telefon.

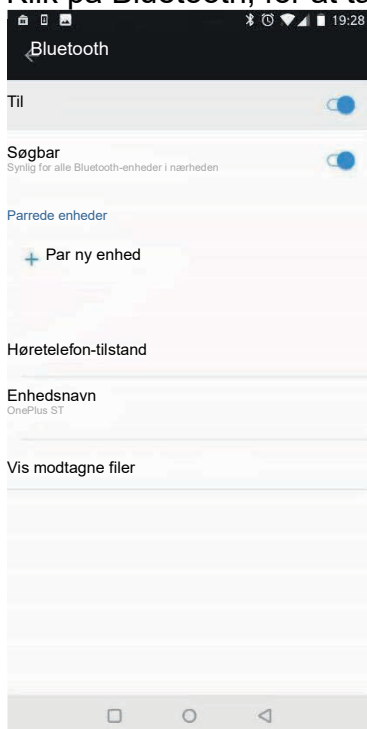

- (3). Klik på parring af den nye enhed; smartphonen begynder at søge efter en ny Bluetooth-enhed inden for rækkevidde. Søger efter "BSD-BT", klik for at parre. Når du hører en bip-tone, så er parringen lykkedes.

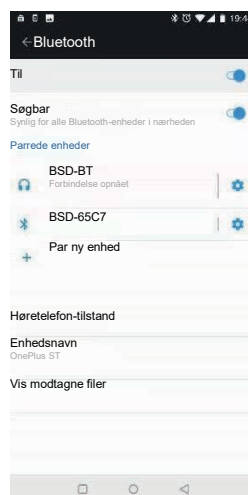
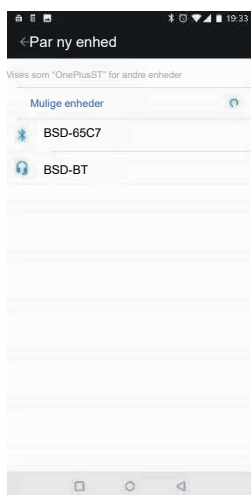

- 3: Når parringen er lykkedes, skal du åbne musikafspilleren på mobiltelefonen, for at afspille musikken. Fjernbetjeningen bruges til at styre Bluetooth under afspilning af musik. Betjening som følger:

 Lydstyrke + ;

 Lydstyrke - ;

 Forrige nummer ;

 Næste nummer ;

 Spil/Pause; denne knap fungerer, når Bluetooth-forbindelsen mellem smartphonen og musiklydene er lykkedes.

 Aktivér lyskontrol-funktionen, (kun hvis du trykker på denne knap først, kan du bruge Lydstyrke + , Lydstyrke - , Forrige nummer og Næste nummer på

den midterste navigationsknap  til at ændre musikken.

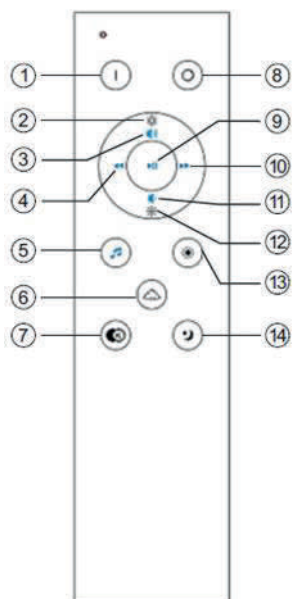

1. Κουμπί ενεργοποίησης (μόνο για θερμό φωτισμό) με λειτουργία μνήμης
2. Αύξηση φωτεινότητας μετά την ενεργοποίηση
3. Αύξηση έντασης ήχου
4. Προηγούμενο τραγούδι
5. Κουμπί ενεργοποίησης Bluetooth
6. Ρύθμιση RGB
7. Ρύθμιση φωτεινότητας σε τρία διαφορετικά επίπεδα
8. Απενεργοποίηση
9. Ενεργοποίηση/απενεργοποίηση
10. Επόμενο τραγούδι
11. Μείωση έντασης ήχου
12. Μείωση φωτεινότητας μετά την ενεργοποίηση
13. Κουμπί ενεργοποίησης ρυθμίσεων φωτεινότητας (μόνο για θερμό φωτισμό)
14. Νυχτερινός φωτισμός

## Οδηγίες:

### 1. Ρύθμιση φωτισμού

1: Ανοίξτε τον διακόπτη λειτουργίας (διακόπτης τροφοδοσίας εναλλασσόμενου ρεύματος) στο τοποθετημένο φωτιστικό οροφής και το φωτιστικό θα ανάψει εκπέμποντας θερμό φωτισμό (θερμός φωτισμός).

2: Τώρα, μπορείτε να χρησιμοποιήσετε το τηλεχειριστήριο για να προσαρμόσετε τη φωτεινότητα του βασικού φωτισμού (θερμός φωτισμός) και το χρώμα του φωτισμού RGB. Οι διαθέσιμες λειτουργίες είναι οι εξής:

Ενεργοποιεί τον θερμό φωτισμό και εφαρμόζει τη ρύθμιση φωτεινότητας που ίσχυε την τελευταία φορά που απενεργοποιήσατε το φωτιστικό. Για τον φωτισμό RGB και τον νυχτερινό φωτισμό δεν υπάρχει δυνατότητα αποθήκευσης των ρυθμίσεων.

Απενεργοποιεί το φωτιστικό (θερμό φωτισμό και φωτισμό RGB).

Αυξάνει σταδιακά τη φωτεινότητα του θερμού φωτισμού.

Μειώνει σταδιακά τη φωτεινότητα του θερμού φωτισμού.

Ενεργοποιεί τη λειτουργία ρύθμισης φωτισμού. (Για να χρησιμοποιήσετε το κεντρικό κουμπί

για να προσαρμόσετε τη φωτεινότητα του θερμού φωτισμού, πρέπει να έχετε πατήσει πρώτα αυτό το κουμπί.)

Πραγματοποιεί εναλλαγή της λειτουργίας RGB. 5 καταστάσεις λειτουργίας: (1). Κόκκινο φως, (2). Πράσινο φως, (3). Μπλε φως, (4). Σταδιακή εναλλαγή 7 χρωμάτων, (5). Ξαφνική αλλαγή 7 χρωμάτων

3 επίπεδα φωτεινότητας, 35%--68%--100%.

Νυχτερινός φωτισμός.



## II. Ρύθμιση μουσικής

1: Ανοίξτε τον διακόπτη λειτουργίας (διακόπτης τροφοδοσίας εναλλασσόμενου ρεύματος) στο τοποθετημένο φωτιστικό οροφής και το φωτιστικό θα ανάψει εκπέμποντας θερμό φωτισμό. (θερμός φωτισμός)

2: Πραγματοποιήστε σύζευξη Bluetooth:

(1). Ανοίξτε το μενού ρυθμίσεων του smartphone σας.

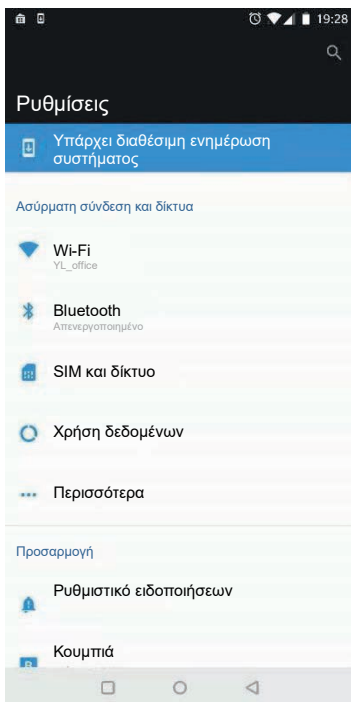

(2). Πατήστε «Bluetooth» για να ενεργοποιήσετε τη λειτουργία Bluetooth του κινητού σας.

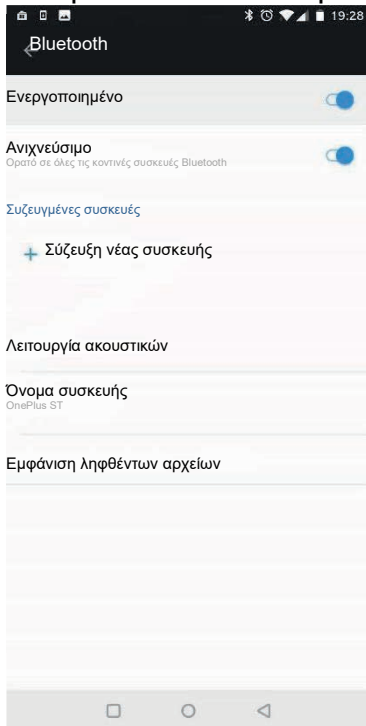

(3). Επιλέξτε να γίνει σύζευξη νέας συσκευής. Το smartphone θα αρχίσει να αναζητά τις νέες συσκευές Bluetooth που υπάρχουν εντός εμβέλειας. Κάντε αναζήτηση για τη συσκευή «BSD-BT» και επιλέξτε να γίνει σύζευξη. Όταν ακούσετε το ηχητικό σήμα, η σύζευξη έχει ολοκληρωθεί επιτυχώς.

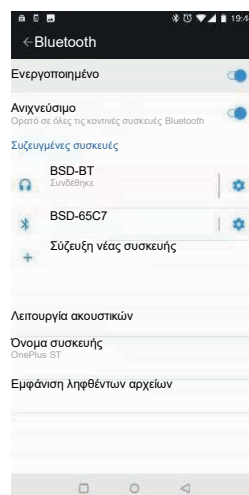
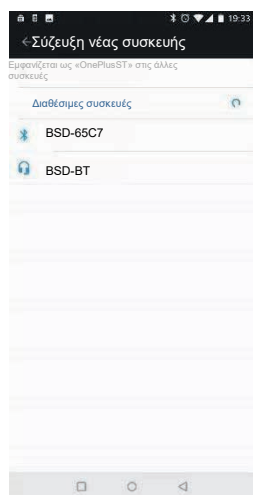
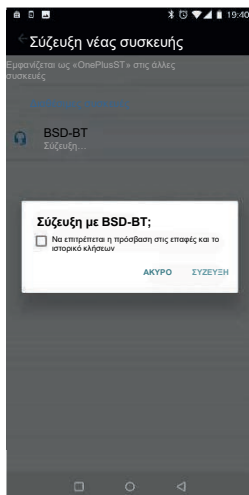

3: Αφού ολοκληρωθεί επιτυχώς η σύζευξη, ανοίξτε την εφαρμογή αναπαραγωγής μουσικής στο κινητό σας για να ακούσετε μουσική. Κατά την αναπαραγωγή μουσικής, μπορείτε να χρησιμοποιήσετε το τηλεχειριστήριο για τη ρύθμιση του Bluetooth. Οι διαθέσιμες λειτουργίες είναι οι εξής:



Αύξηση έντασης ήχου



Μείωση έντασης ήχου



Προηγούμενο τραγούδι



Επόμενο τραγούδι



Αναπαραγωγή/Διακοπή: Το κουμπί αυτό λειτουργεί όταν υπάρχει σύνδεση Bluetooth μεταξύ του smartphone και του φωτισμού μουσικής.



Ενεργοποίηση της λειτουργίας ρύθμισης φωτισμού (μόνο αν πατήσετε πρώτα αυτό το κουμπί μπορείτε να χρησιμοποιήσετε το κεντρικό κουμπί



για να αυξήσετε ή να μειώσετε την ένταση του ήχου και να επιλέξετε το προηγούμενο ή το επόμενο τραγούδι .

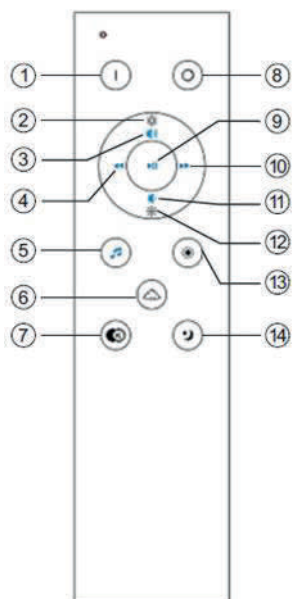









1. Sisselülitus (üksnes sooja valguse jaoks) koos mälufunktsiooniga
2. Heledus + pärast aktiveerimist
3. Helitugevus +
4. Eelmine laul
5. Aktiveerimisnupp Bluetooth-funktsiooni jaoks
6. RGB-juhtimine
7. Heleduse juhtimine kolme eritasandi jaoks
8. Väljalülitus
9. Sisse/välja
10. Järgmine laul
11. Helitugevus -
12. Heledus -, pärast aktiveerimist
13. Heleduse juhtimise aktiveerimise nupp (üksnes sooja valguse jaoks)
14. Öövalgus

## Juhised:

### I. Valgustuse juhtimine

1: Lülitage sisse paigaldatud laevalgusti elektrilüliti (AC-elektrilüliti) ja laevalgusti soe valgus süttib (soe valgus).

2: Saate nüüd põhivalguse (soe valgus) ja RGB värvuse kohandamiseks kasutada kaugjuhtimisseadet. Käsitsemine toimub järgmiselt:

-  Lülitage sisse soe valgus, pidage meeles heledust, kui valgus oli viimati välja lülitatud, GB-I ja öövalgusel puudub mälufunktsioon
-  Lülitage valgus välja (soe valgus ja RGB-valgus mõlemad välja)
-  Ülespoole reguleerimine suurendab sooja valguse heledust
-  Allapoole reguleerimine vähendab sooja valguse heledust
- Aktiveerige valguse juhtimise funktsioon (ainult siis, kui vajutate seda klahvi esimesena, saate  sooja valguse heledust muutmiseks kasutada ülespoole ja allapoole reguleerimist navigeerimisklahvi keskel;)
-  RGB-režiimile lülitumine. 5 režiimi: (1). punane valgus; (2). roheline valgus; (3). sinine valgus; (4). 7 värvusega valguse astmeline muutmine; (5). 7 värvusega valguse järsk muutmine;
-  3-astmeline heledus, 35%--68%---100%
-  Öövalgus;

### II. Muusika juhtimine

1: Lülitage sisse paigaldatud laevalgusti elektrilüliti (AC-elektrilüliti) ja laevalgusti soe valgus süttib (soe valgus).

## 2: Bluetoothiga ühendamine

(1). Sisenege nutitelefone seadistuste liidesesse.



(2). Vajutage Bluetoothile, et lülitada sisse oma telefoni Bluetooth-funktsioon.

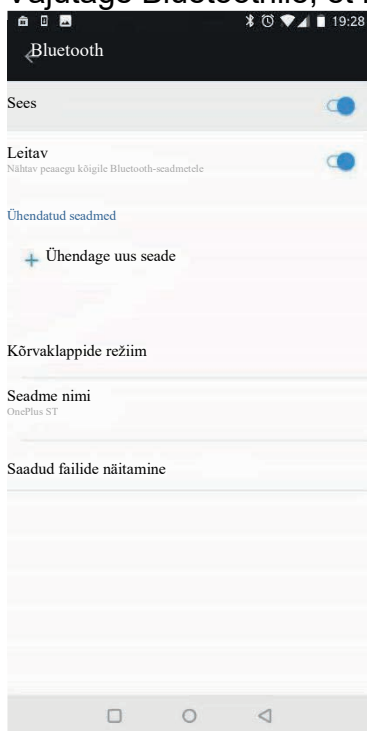

(3). Vajutage uue seadme ühendamisele; nutitelefon alustab vahemikus oleva uue Bluetooth-seadme otsimist. Otsige „BSD-BT” ja vajutage ühendamiseks. Kui kuulete piiksumisheli, siis oli ühendamine edukas.

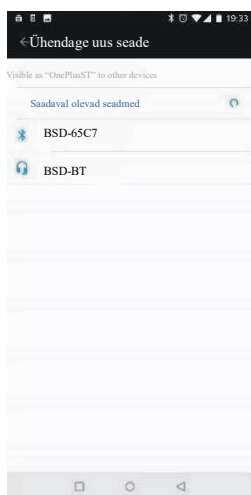

3: Kui ühendamine on edukas, avage muusika mängimiseks mobiiltelefonil muusikapleier. Muusika mängimise ajal saab kaugjuhtimisseadet kasutada Bluetoothi juhtimiseks. Toimige järgmiselt:

 Helitugevus +

 Helitugevus -

 Eelmine laul

 Järgmine laul

 Mängimine/paus; see klahv töötab, kui Bluetoothi ühendamine nutitelefonil ja muusikavalgusega õnnestus.

 Aktiveerige valguse juhtimise funktsioon, (üksnes siis, kui vajutate seda klahvi esimesena, saate muusika vahetamiseks kasutada „Helitugevus +“, „Helitugevus -“, „Eelmine laul“ ja „Järgmine laul“ keskmisel

navigeerimisklahvil .

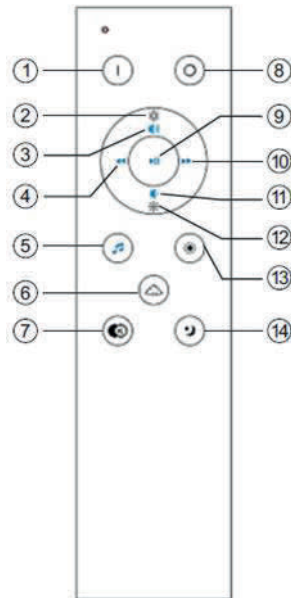











1. Päällekytkentä (vain lämmin valo), muistitoiminnolla
2. Kirkkaus + aktivoinnin jälkeen
3. Äänenvoimakkuus +
4. Edellinen kappale
5. Bluetooth-toiminnon aktivointipainike
6. RGB-valovärin hallinta
7. Kirkkauden säätö kolmelle eri tasolle
8. Poiskytkentä
9. On/Off (Päälle/Pois)
10. Seuraava kappale
11. Äänenvoimakkuus -
12. Kirkkaus - aktivoinnin jälkeen
13. Aktivointipainike kirkkauden hallinnalla (vain lämmin valo)
14. Yövalo

## Ohjeet:

### I. Valaistuksen hallinta

1: Kytke asennetun kattovalaisimen virtakytkin päälle (AC-virtakytkin), ja kattovalaisimen lämmin valo syttyy (lämmin valo).

2: Nyt voit käyttää kaukosäädintä päävalon kirkkauden säätämiseen (lämmin valo) ja RGB-valovärin valitsemiseen. Käyttö tapahtuu seuraavasti:

-  Lämpimän valon päällekytkentä, muista kirkkaus viime poiskytkennästä, RGB-valovärillä ja yövalolla ei ole tallennustoimintoa
-  Valon poiskytkentä (sekä lämmin valo että RGB-valo pois)
-  Himmennyksen vähentäminen, lisää lämpimän valon kirkkautta
-  Himmennys, vähennä lämpimän valon kirkkautta
-  Valon hallinnan toiminnon aktivoiminen (jos painat tätä painiketta ensin, voit käyttää  himmennyspainikkeita keskiohjaimesta  säätääksesi lämpimän valon kirkkautta)
-  RGB-tilakytkentä. 5 tilaa: (1). Punainen valo; (2). Vihreä valo; (3). Sininen valo; (4). 7 värin valon vähittäinen muutos; (5). 7 värin valon nopea muutos
-  3-asteinen kirkkaus, 35 %--68 %---100 %
-  Yövalo

### II. Musiikin ohjaus

1: Kytke asennetun kattovalaisimen virtakytkin päälle (AC-virtakytkin), ja kattovalaisimen lämmin valo syttyy. (lämmin valo)

## 2: Parita Bluetooth

### (1). Siirry älypuhelimien asetuksiin

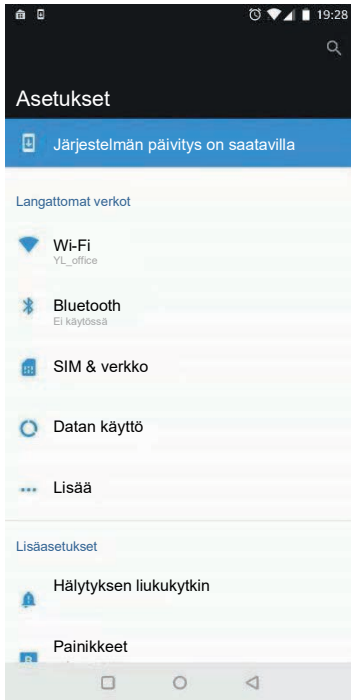

### (2). Paina Bluetooth-kuvaketta kytkeäksesi puhelimesi Bluetooth-toiminnon päälle

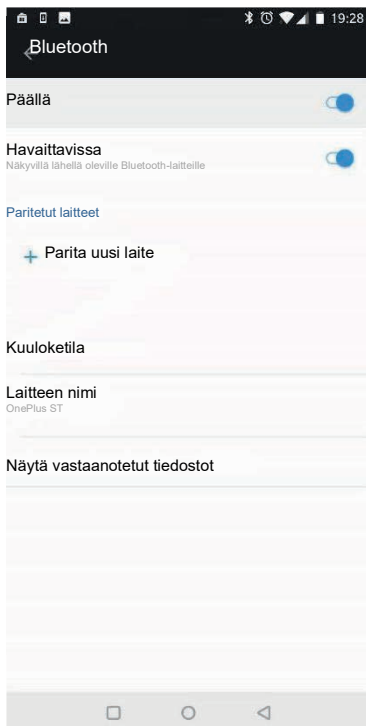



(3). Paina parittaaksesi uuden laitteen; älypuhelin alkaa etsiä uutta lähistöllä olevaa Bluetooth-laitetta. Etsii "BSD-BT", paina luodaksesi parin. Kun kuulet piippauksen, parin luominen on onnistunut.

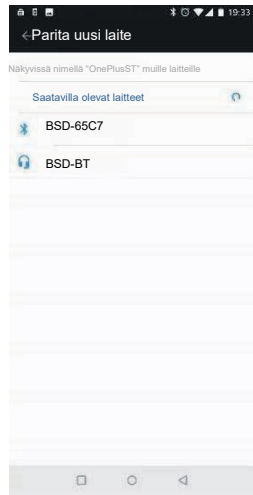

3: Kun pari on luotu, avaa älypuhelimiesi musiikkisoitin kuunnellaksesi musiikkia. Kuuntelun aikana kaukosäätimellä voi ohjatta Bluetooth-laitetta. Käyttö tapahtuu seuraavasti:

 Äänenvoimakkuus +

 Äänenvoimakkuus -

 Edellinen kappale

 Seuraava kappale

 Toisto/Keskeytyks; tämä painike toimii, kun Bluetooth on yhdistetty älypuhelimeen ja musikaalisiin valoihin.

 Valon hallinnan toiminnon aktivoiminen (jos painat tätä painiketta ensin, voit valita Äänenvoimakkuus + ja -, Edellinen kappale ja Seuraava kappale

keskiohjaimesta  vaihtaaksesi kappaletta.

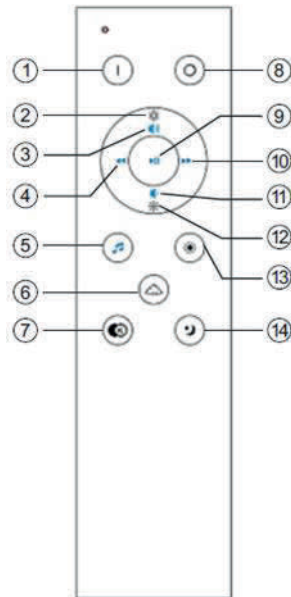









15. Upalite (samo za toplo svjetlo) pomoću memorijske funkcije
16. Jačina osvjetljenja +, nakon aktiviranja
17. Jačina zvuka +
18. Prethodna pjesma
19. Gumb za aktiviranje funkcije Bluetooth uređaja
20. Kontrola za RGB boje (crvena, zelena, plava)
21. Kontrola jačine svjetlosti za tri različite razine
22. Isključi
23. Uključi / Isključi
24. Sljedeća pjesma
25. Jačina zvuka -
26. Jačina osvjetljenja -, nakon aktiviranja
27. Gumb za aktiviranje kontrole jačine osvjetljenja (samo za toplo svjetlo)
28. Noćno svjetlo

## Upute:

### III. Kontrola osvjetljenja

1: Uključite prekidač za napajanje (prekidač izmjenične struje) instalirane stropne lampe i sa stropa će zasjati topla svjetlost (toplo svjetlo)

2: Nakon toga možete upotrijebiti daljinski upravljač kako biste prilagodili jačinu glavne svjetlosti (toplo svjetlo) i boju RGB (crvena, zelena, plava) svjetla. Postupak je sljedeći:

-  Uključite toplo svjetlo, sjetite se njegove jačine kad ste ga zadnji put ugasi. RGB i noćno svjetlo nemaju memorijsku funkciju
-  Isključite svjetlo (isključeno je i toplo svjetlo i RGB)
-  Pojačajte prigušenu svjetlost, pojačajte svjetlost toplog svjetla
-  Smanjite prigušenu svjetlost, smanjite svjetlost toplog svjetla
- Aktivirajte funkciju kontrole svjetlosti (samo ako prvo pritisnete taj gumb, možete koristiti srednji gumb za navigaciju prigušivanja ili pojačavanja, kako biste prilagodili  jačinu tople svjetlosti;)
-  Prebacivanje načina rada za boje RGB (crvena, zelena, plava) 5 načina: (1). Crveno svjetlo; (2). Zeleno svjetlo; (3). Plavo svjetlo; (4). Postepena promjena svjetla u 7 boja; (5). Iznenadna promjena svjetla u 7 boja
-  3 razine jačine svjetlosti, 35%--68%---100%
-  Noćno svjetlo

## IV. Kontrola glazbe

1: Uključite prekidač (prekidač izmjenične struje) za napajanje instalirane stropne lampe i sa stropa će zasjati topla svjetlost stropne lampe. (toplo svjetlo)

2: Uparite s Bluetooth uređajem

(1). Unesite postavke sa sučelja pametnog telefona.

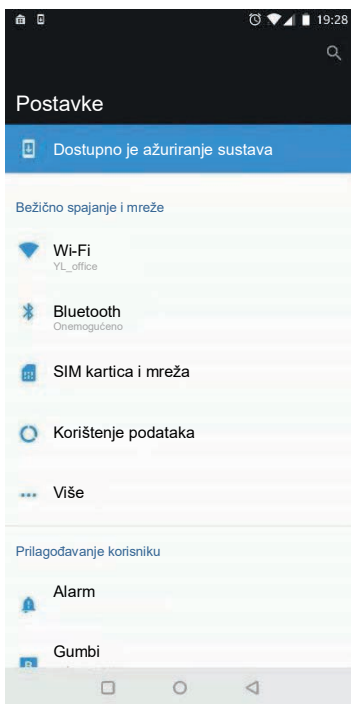

(2). Kliknite na Bluetooth, kako biste uključili funkciju za Bluetooth na vašem telefonu.

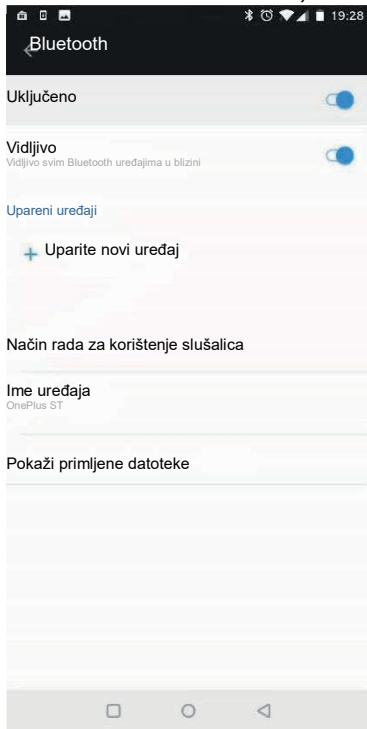

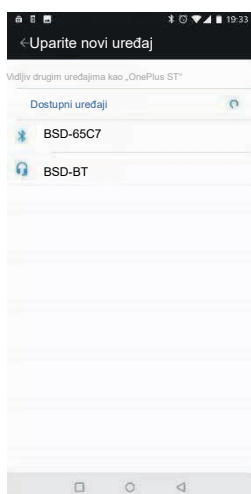

(3). Kliknite za uparivanje novog uređaja; pametni telefon počinje potragu za novim Bluetooth uređajem unutar dometa. Traženje "BSD-BT", kliknite za uparivanje. Kada začujete zvuk signala, uparivanje jeuspjelo.



3: Nakon uspješnog uparivanja, za reprodukciju glazbe otvorite čitač glazbe na mobilnom telefonu. Za vrijeme reprodukcije glazbe, Bluetooth uređajem može se upravljati daljinskim upravljačem. Postupak je sljedeći:

 Jačina zvuka +;

 Jačina zvuka -;

 Prethodna pjesma;

 Sljedeća pjesma;

 Sviraj/pauziraj; ovaj gumb radi kad je Bluetooth uređaj uspješno povezan s pametnim telefonom i svjetlom uz glazbu.

 Aktivirajte funkciju kontrole svjetlosti (samo ako prvo pritisnete ovaj gumb, možete koristiti funkcije: Jačina zvuka + i Jačina zvuka - za glasnoću, te Prethodna pjesma i Sljedeća pjesma, na srednjem gumbu za navigaciju,



kako biste promijenili glazbu.

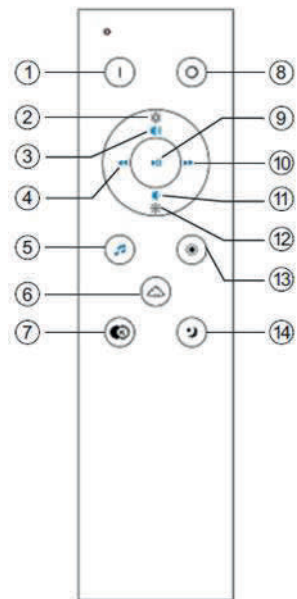

1. Bekapcsolás (csak meleg fényhez) memória funkcióval
2. A fényerő növelése (+) a funkció aktiválása után
3. A hangerő növelése (+)
4. Előző zeneszám
5. A Bluetooth funkció aktiváló gombja
6. Színbeállítás (RGB-vezérlés)
7. A fényerő-beállítása három különböző szintre
8. Kikapcsolás
9. Lejátszás/szünet
10. Következő zeneszám
11. A hangerő csökkentése (-)
12. A fényerő csökkentése (-) a funkció aktiválása után
13. A fényerő-szabályozás aktiváló gombja (csak meleg fényhez)
14. Éjjeli fény

## Használati utasítás:

### I. A világítás szabályozása

1: Állítsa a felszerelt mennyezeti lámpa kapcsolóját (a hálózati kapcsolót) bekapcsolt pozícióba, és a mennyezeti lámpa meleg fényvel kezd világítani (meleg fény).

2: Ekkor a távirányítóval beállíthatja az elsődleges világítás (meleg fény) fényerejét, valamint az RGB világítás színét. Ez a következőképpen hajtható végre:

- Ezzel a gombbal kapcsolhatja be a meleg fényt. A lámpa emlékszik az utolsó kikapcsoláskor használt fényerőre. Az RGB üzemmódnak és az éjjeli fénynek nincs memória funkciója.
- Ezzel a gombbal kapcsolhatja ki a világítást (a meleg fény és az RGB világítás egyaránt kialszik).
- Ezzel a gombbal növelhető a meleg fény fényereje.
- Ezzel a gombbal csökkenthető a meleg fény fényereje.
- Ezzel a gombbal aktiválhatja a fényerő-szabályozást (a középső navigációs gomb  csak azt követően teszi lehetővé a meleg fény fényerejének csökkentését vagy növelését, ha előbb megnyomja ezt a gombot).
- Ezzel a gombbal tud váltani az RGB üzemmódok között. 5 üzemmód érhető el: 1. piros fény, 2. zöld fény, 3. kék fény, 4. 7 szín fokozatos átmenetű váltakozása. 5. 7 szín hirtelen váltakozása.
- Háromszintű fényerő-beállító: 35%–68%–100%.
- Éjjeli fény.

### II. A zene vezérlése

1: Állítsa a felszerelt mennyezeti lámpa kapcsolóját (a hálózati kapcsolót) bekapcsolt pozícióba, és a mennyezeti lámpa meleg fényvel kezd világítani (meleg fény).

2: Párosítsa a lámpát és az okostelefont Bluetooth kapcsolaton keresztül.

(1). Lépjen be az okostelefon beállítási menüjébe.

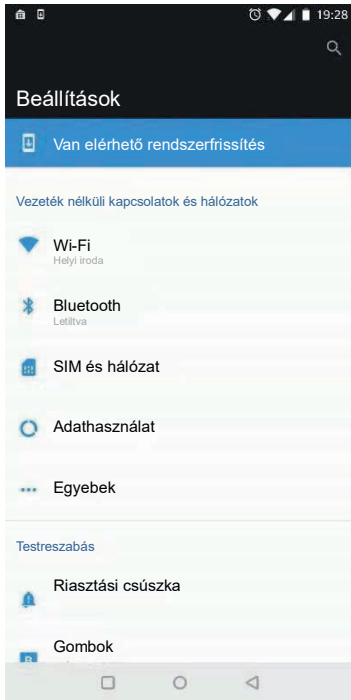

(2). Az okostelefon Bluetooth funkciójának bekapcsolásához koppintson a Bluetooth menüpontra.

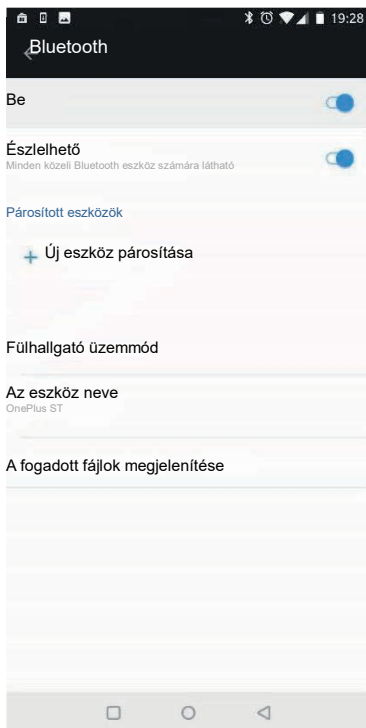

- (3). Koppintson az Új eszköz párosítása menüpontra. Az okostelefon keresni kezdi a hatótávolságán belül található új Bluetooth eszközöket. Keresse meg a listán a BSD-BT eszközt, és koppintson rá a párosítás elindításához. Sikeres párosítást követően a készülék hangjelzést ad ki.

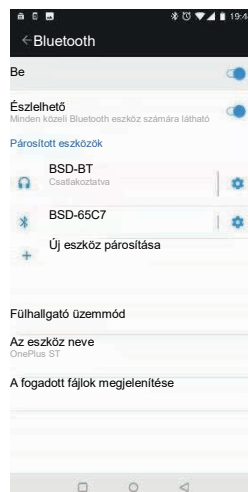
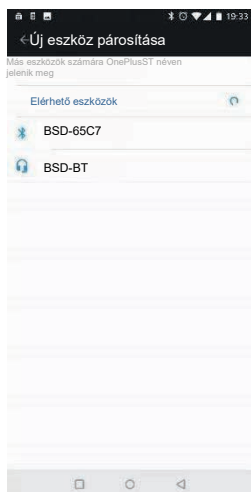

- 3: Sikeres párosítást követően zenehallgatáshoz nyissa meg az okostelefon zenelejátszóját. Zene lejátszása közben a távirányító a Bluetooth kapcsolat kezelőszerveként használható. A következő műveleteket hajthatja végre:



A hangerő növelése (+)



A hangerő csökkentése (-)



Ugrás az előző zeneszámra



Ugrás a következő zeneszámra



Lejátszás/a lejátszás szüneteltetése; ez a gomb akkor használható, ha az okostelefon és a hangszórós lámpa között létrejött a Bluetooth kapcsolat.



Ezzel a gombbal aktiválhatja a zenelejátszás vezérlését (a középső



navigációs gomb csak azt követően teszi lehetővé a hangerő csökkentését és növelését, illetve az előző vagy a következő zeneszámra ugrást, ha előbb megnyomja ezt a gombot).



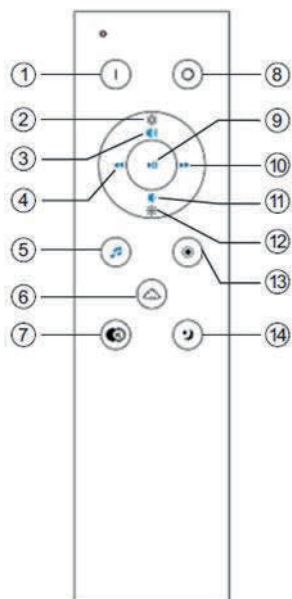









1. Įjungimas (tik švelnios spalvos šviesai) su atminties funkcija
2. Ryškumo didinimas, kai įjungta
3. Garso didinimas
4. Ankstesnis garso įrašas
5. „Bluetooth“ funkcijos įjungimo mygtukas
6. RGB valdymas
7. Trijų skirtingų lygių ryškumo valdymas
8. Išjungimas (OFF)
9. Įjungimas (ON) / išjungimas (OFF)
10. Sekantis garso įrašas
11. Garso mažinimas
12. Ryškumo mažinimas, kai įjungta
13. Ryškumo valdymo įjungimo mygtukas (tik švelnios spalvos šviesai)
14. Naktinis apšvietimas

## Instrukcijos:

### I. Apšvietimo valdymas

1: Norėdami įjungti šviesą (švelnaus tono), paspauskite sumontuoto lubų šviestuvo jungiklį (kintamosios srovės maitinimo jungiklį).

2: Dabar galite nuotolinio valdymo pulteliu keisti pagrindinės šviesos (švelnių tonų) ryškumą ir RGB spalvas. Toliau nurodyti galimi šviestuvo valdymo veiksmai:

-  Švelnių tonų šviesos įjungimas išlaikant ryškumą, kuris buvo nustatytas paskutinį kartą išjungiant šviestuvą; atminties funkcija netaikoma RGB ir naktinei šviesai
-  Šviesos išjungimas (švelnių tonų ir RGB šviesas)
-  Švelnių tonų šviesos ryškumo padidinimas
-  Švelnių tonų šviesos ryškumo sumažinimas
-  Šviesos valdymo funkcijos įjungimas (tik pirma nuspaudę šį mygtuką viduriniu navigaciniu mygtuku  galite padidinti arba sumažinti švelnių tonų šviesos ryškumą)
-  RGB režimo keitimas. Galimi 5 režimai: 1. raudona šviesa; 2. žalia šviesa; 3. mėlyna šviesa; 4. palaipsniui kintančių 7 spalvų režimas; 5. staiga kintančių 7 spalvų režimas
-  3 lygių pasirenkamas ryškumas: 35%, 68% ir 100%
-  Naktinis apšvietimas

### II. Garso įrašų valdymas

1: Norėdami įjungti šviesą (švelnaus tono), paspauskite sumontuoto lubų šviestuvo jungiklį (kintamosios srovės maitinimo jungiklį).

- 2: Susiekite prietaisą su „Bluetooth“.
- (1). Įeikite į išmaniojo telefono nustatymų meniu.

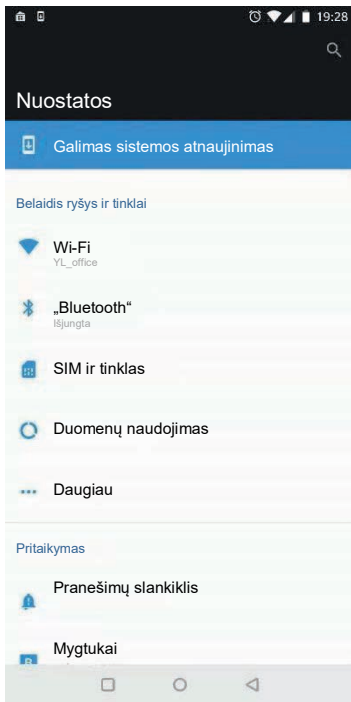



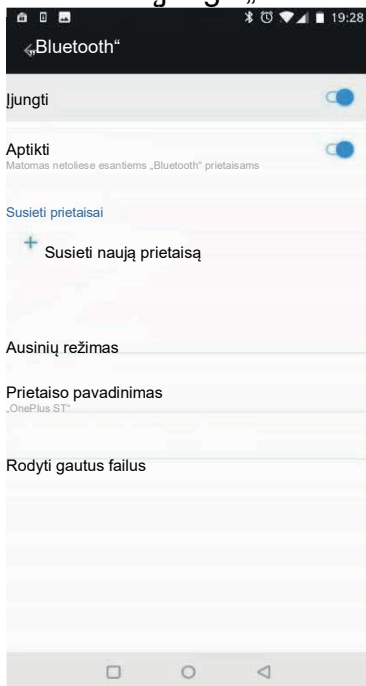

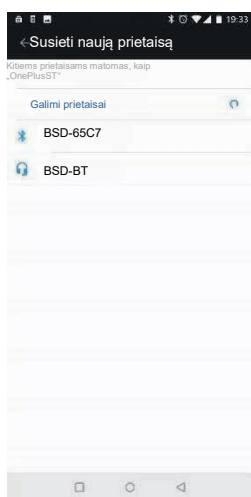

- (2). Norėdami įjungti „Bluetooth“, spustelėkite telefone „Bluetooth“ funkcijos ikoną.



- (3). Pasirinkite naujo prietaiso susiejimo funkciją; išmanusis telefonas pradės naujo pasiekiamo „Bluetooth“ prietaiso paiešką. Ieškoma „BSD-BT“, norėdami susieti, spustelėkite klavišą. Kai prietaisai bus susieti, išgirsite garsinį signalą.



3. Kai prietaisai bus susieti mobiliajame telefone, atidarykite garso įrašų paleidimo programėlę. Paleidę garso įrašą, nuotolinio valdymo pulteliu galite kontroliuoti „Bluetooth“ prietaisą. Galimi šie veiksmai:

-  Garso didinimas
  -  Garso mažinimas
  -  Ankstesnis garso įrašas
  -  Sekantis garso įrašas
  -  Paleidimas (PLAY) / stabdymas (PAUSE); šis mygtukas veiks sėkmingai, kai „Bluetooth“ prietaisas bus susietas su išmaniuoju telefonu bei muzikos šviesomis.
  -  Šviesų valdymo funkcijos įjungimas (tik pirma nuspaudę šį mygtuką
- viduriniu navigacijos mygtuku  galite padidinti arba sumažinti garsą ir įjungti sekantį arba ankstesnį garso įrašą).

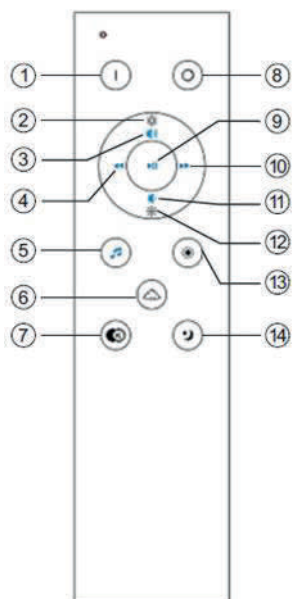

1. Ijungimas (tik švelnios spalvos šviesai) su atminties funkcija
2. Ryškumo didinimas, kai įjungta
3. Garsumo didinimas
4. Ankstesnis garso įrašas
5. „Bluetooth“ funkcijos įjungimo mygtukas
6. RGB valdymas
7. Trijų skirtingų lygių ryškumo valdymas
8. Išjungimas (OFF)
9. Įjungimas (ON) / išjungimas (OFF)
10. Sekantis garso įrašas
11. Garsumo mažinimas
12. Ryškumo mažinimas, kai įjungta
13. Ryškumo valdymo įjungimo mygtukas (tik švelnios spalvos šviesai)
14. Naktinis apšvietimas

## Instrukcijos:

### I. Apšvietimo valdymas

1: Norėdami įjungti šviesą, (švelnaus tono), paspauskite sumontuoto lubų šviestuvo jungiklį (kintamosios srovės maitinimo jungiklį).

2: Dabar galite nuotolinio valdymo pulteliu keisti pagrindinės šviesos ryškumą (švelnių tonų šviesos) ir RGB spalvas. Toliau nurodyti galimi šviestuvo valdymo veiksmai:

- Galite įjungti švelnių tonų šviesą, tokio ryškumo, koks buvo paskutinį kartą išjungiant šviestuvą; atminties funkcija netaikoma RGB ir naktinei šviesai.
- Galite išjungti šviesą (švelnių tonų ir RGB šviesas).
- Galite padidinti švelnių tonų šviesos ryškumą.
- Galite sumažinti švelnių tonų šviesos ryškumą.
- Galite įjungti šviesos valdymo funkciją (tik pirma nuspaudę šį mygtuką viduriniu navigaciniu mygtuku galite keisti švelnių tonų šviesos ryškumą).
- Galite keisti RGB režimą. Galimi 5 režimai: 1. Raudona šviesa. 2. Žalia šviesa. 3. Mėlyna šviesa. 4. Palaipsniui kintančių 7 spalvų režimas. 5. Staiga kintančių 7 spalvų režimas.
- 3 lygių pasirenkamas ryškumas: 35%, 68% ir 100%.
- Naktinis apšvietimas.

### II. Garso įrašų valdymas

1: Norėdami įjungti šviesą (švelnaus tono), paspauskite sumontuoto lubų šviestuvo jungiklį (kintamosios srovės maitinimo jungiklį).

2: Susiekite prietaisą su „Bluetooth“.

(1). Įjunkite išmaniojo telefono nustatymų meniu.

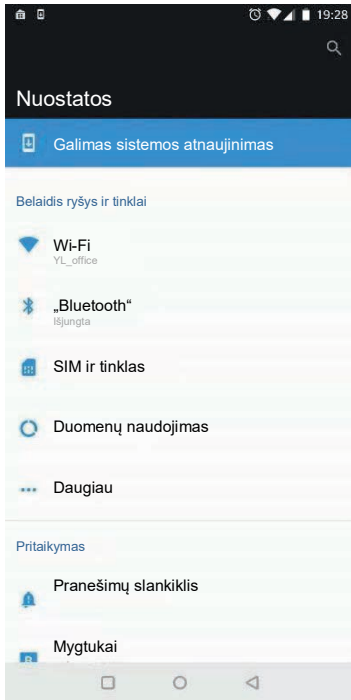

(2). Norėdami įjungti „Bluetooth“, įjunkite telefone „Bluetooth“ funkciją.



- (3). Pasirinkite naujo prietaiso susiejimo funkciją; išmanusis telefonas pradės naujo pasiekiamo „Bluetooth“ prietaiso paiešką. Ieškoma „BSD-BT“, norėdami susieti, spustelėkite. Susieję prietaisą išgirsite garsinį signalą.

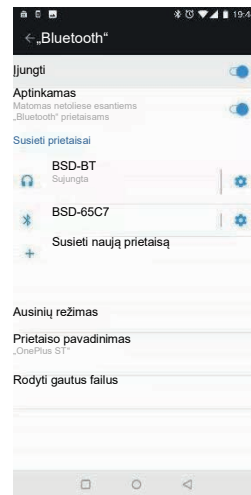
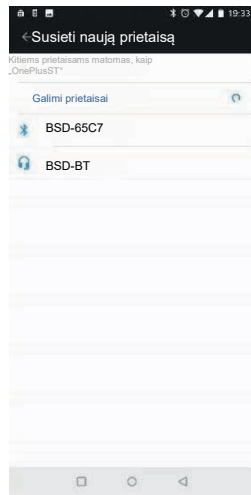

- 3: Susieję prietaisus mobiliajame telefone, atidarykite garso įrašų paleidimo programėlę. Paleidę garso įrašą, nuotolinio valdymo pulteliu galite kontroliuoti „Bluetooth“ prietaisą. Galimi šie veiksmai:



Garsumo didinimas



Garsumo mažinimas



Ankstesnis garso įrašas



Sekantis garso įrašas



Paleidimas (PLAY) / stabdymas (PAUSE); šis mygtukas aktyvus sėkmingai susiejus „Bluetooth“ prietaisą ir įjungus su muziką susietas šviesas.



Valdyti šviesų funkciją (tik pirma nuspaudę šį mygtuką viduriniu

navigacijos mygtuku



galite keisti garsumą ir įjungti sekantį arba ankstesnį garso įrašą.

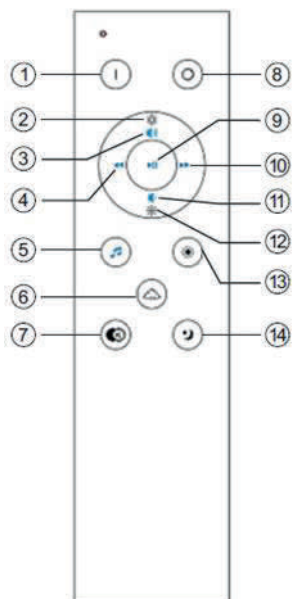









1. Inschakelen (alleen voor warm licht), met geheugenfunctie
2. Helderheid + na activering
3. Volume +
4. Vorig liedje
5. Activeerknop voor Bluetooth-functie
6. RGB-bediening
7. Helderheidsregeling voor drie verschillende niveaus
8. Uitschakelen
9. Aan/uit
10. Volgend liedje
11. Volume -
12. Helderheid -, na activering
13. Activeerknop voor helderheidsregeling (alleen voor warm licht)
14. Nachtlamp

## Aanwijzingen:

### I. Verlichtingsregeling

1: Schakel de stroomschakelaar (wisselstroomschakelaar) van de geïnstalleerde plafondverlichting in en het warme licht van de plafondverlichting gaat branden (warm licht).

2: Op dit moment kunt u de afstandsbediening gebruiken om de helderheid van het hoofdlicht (warm licht) en de kleur van de RGB. aan te passen. De bediening gebeurt als volgt:

-  Schakel het warme licht aan, onthoud de helderheid toen het licht de vorige keer werd uitgeschakeld, RGB en nachtlampje hebben geen geheugenfunctie
-  Schakel het licht uit (warm licht en RGB-licht beide uit)
-  Opdimmen, de helderheid van het warme licht verhogen
-  Neerdimmen, de helderheid van het warme licht verminderen
-  Activeer de lichtbesturingsfunctie (alleen wanneer u eerst op deze toets drukt, kunt u op- en neerdimmen op de middelste navigatietoets gebruiken om  de helderheid van het warme licht aan te passen;)
-  RGB-modus omschakelen. 5 modi: (1). Rood licht; (2). Groen licht; (3). Blauw licht; (4). geleidelijke verandering 7-kleurenlicht; (5).plotselinge verandering 7-kleurenlicht;
-  helderheid met 3 niveaus, 35%--68%---100%
-  Nachtlampje

### II. Muziekbesturing

1: Schakel de stroomschakelaar (wisselstroomschakelaar) van de geïnstalleerde plafondverlichting in en het warme licht van de plafondverlichting gaat branden. (warm licht)

## 2: Koppel de Bluetooth

(1). Open de instellingen-interface van de smartphone.

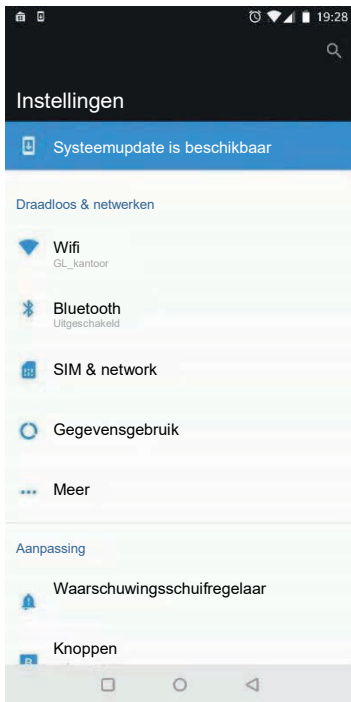

(2). Klik op Bluetooth om de Bluetooth-functie van uw telefoon in te schakelen.





- (3). Klik op koppelen van het nieuwe apparaat; de smartphone begint te zoeken naar een nieuw Bluetooth-apparaat binnen bereik. Zoeken naar "BSD-BT", klik om te koppelen. Wanneer u een pieptoon hoort, is het koppelen geslaagd.

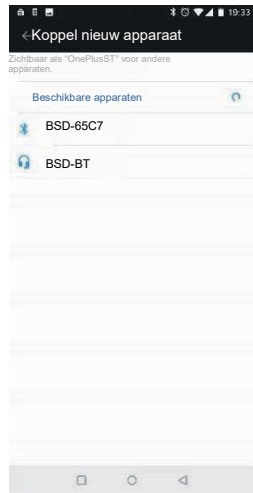

- 3: Wanneer de koppeling is geslaagd, opent u de muziekspeler in de mobiele telefoon om de muziek af te spelen. Tijdens het afspelen van muziek kan de afstandsbediening worden gebruikt om de Bluetooth te bedienen. Bediening als volgt:

 Volume +

 Volume -

 Vorig liedje

 Volgend liedje

 Afspelen/Pauze; deze toets werkt wanneer de Bluetooth-verbinding met de smartphone en de muzieklampjes geslaagd is .

 Activeer de lichtregeling (alleen wanneer u eerst op deze toets drukt, kunt u Volume + , Volume - , Vorig liedje en Volgend liedje op de middelste

navigatietoets  gebruiken om de muziek te wijzigen.

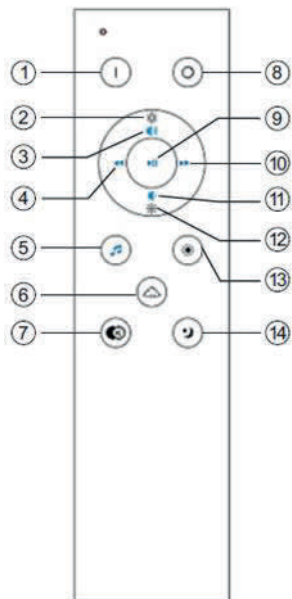









1. Skru på (bare for varmt lys), med minnefunksjon
2. Lysstyrke + etter aktivering
3. Volum +
4. Forrige sang
5. Aktiveringsknapp for Bluetooth-funksjon
6. RGB-kontroll
7. Lysstyrkekontroll for tre forskjellige nivåer
8. Skru av
9. Av/På
10. Neste sang
11. Volum -
12. Lysstyrke -, etter aktivering
13. Aktiveringsknapp for lysstyrkekontroll (bare for varmt lys)
14. Nattdlys

## Instruksjoner:

### I. Lyskontroll

1: Skru på strømbryteren (AC-bryter) for den installerte taklampen, så tennes det varme lyset (varmt lys).

2: Nå kan du bruke fjernkontrollen til å justere lysstyrken til hovedlyset (varmt lys) og RGB-fargen. Bruk som følger:

-  Skru på det varme lyset, og husk lysstyrken fra da lyset sist ble slått av, RGB og nattdlys har ingen minnefunksjon
-  Skru av lyset (både varmt lys og RGB-lys av)
-  Styrke opp, øk lysstyrken til det varme lyset
-  Styrke ned, senk lysstyrken til det varme lyset
- Aktiver lyskontrollfunksjonen (det er bare når du trykker denne tasten først, at du kan bruke
-  styrke opp og styrke ned på midtre navigasjonstast for å justere  styrken til det varme lyset;)
  -  Bytting av RGB-modus. 5 moduser: (1). Rødt lys; (2). Grønt lys; (3). Blått lys; (4). 7-fargers gradvis endring av lyset; (5). 7-fargers plutselig endring av lyset
  -  3 lysstyrkenivåer, 35 %--68 %---100 %
  -  Nattdlys

### II. Musikkontroll

1: Skru på strømbryteren (AC-bryter) for den installerte taklampen, så tennes det varme lyset (varmt lys)

## 2: Paring av Bluetooth

(1). Åpne innstillingene på smarttelefonen.

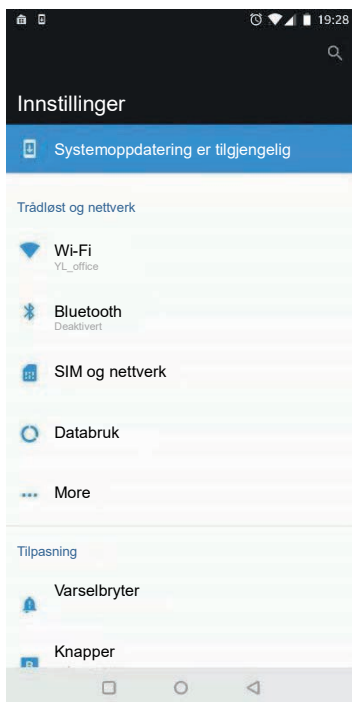

(2). Klikk på Bluetooth for å slå på telefonens Bluetooth-funksjon.

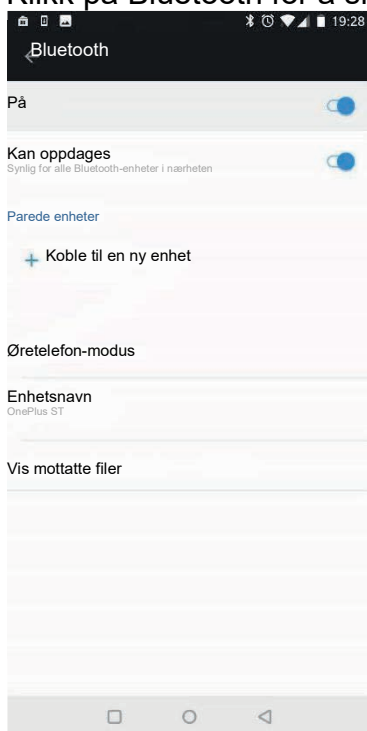

- (3). Klikk for å koble til den nye enheten. Smarttelefonen leter etter en ny Bluetooth-enhet i nærheten. Leter etter «BSD-BT». Klikk for å koble til. Når du hører en pipetone, er tilkoblingen vellykket.

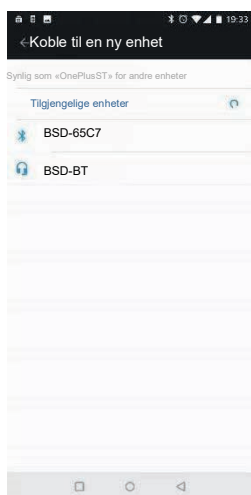
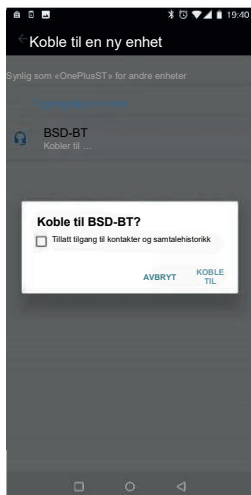

- 3: Når tilkoblingen er vellykket, åpner du musikkspilleren i telefonen for å spille musikk. Mens det spilles musikk kan fjernkontrollen brukes til å kontrollere Bluetoothen. Bruk som følger:

 Volum +

 Volum -

 Forrige sang

 Neste sang

 Spill av/Pause; denne tasten fungerer når Bluetooth-tilkoblingen med smarttelefonen og musikklampen er vellykket.

 Aktiver lyskontrollfunksjonen, (det er bare når du trykker denne tasten først, at du kan bruke Volum + , Volum - , Forrige sang og Neste sang på

midtre navigasjonstast  for å endre musikken.

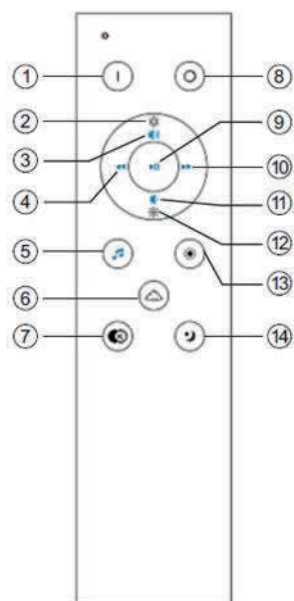









1. Włączenie (tylko światło ciepłe), z funkcją pamięci
2. Zwiększenie jasności, po aktywacji
3. Zwiększenie głośności
4. Poprzedni utwór
5. Przycisk aktywacji funkcji Bluetooth
6. Sterowanie RGB
7. Regulacja jasności: trzy różne poziomy
8. Wyłączenie
9. Wł./Wył.
10. Następny utwór
11. Zmniejszenie głośności
12. Zmniejszenie jasności, po aktywacji
13. Przycisk aktywacji regulacji jasności (tylko światło ciepłe)
14. Oświetlenie nocne

## Instrukcje:

### I. Sterowanie światłem

1: Włącz przełącznik zasilania (przełącznik zasilania sieciowego) zainstalowanej lampy sufitowej. Zaświeci się światło ciepłe lampy sufitowej (światło ciepłe).

2: Teraz można użyć pilota zdalnego sterowania do regulacji jasności światła głównego (światła ciepłego) oraz koloru składowych RGB. Obsługa:

-  Włączenie światła ciepłego z jasnością zapamiętaną podczas ostatniego wyłączenia; składowe barwy RGB i oświetlenie nocne nie są zapamiętane.
-  Wyłączenie światła (zarówno światło ciepłe, jak i światło RGB).
-  Rozjaśnienie, zwiększenie jasności światła ciepłego.
-  Przyciemnienie, zmniejszenie jasności światła ciepłego.
-  Aktywacja funkcji regulacji światła (tylko po uprzednim naciśnięciu tego klawisza, do regulacji jasności światła ciepłego można używać przycisków rozjaśnienia i przyciemniania na środkowym przycisku nawigacji ).
-  Przełączanie trybów RGB. 5 tryby: (1). Światło czerwone; (2). Światło zielone; (3). Światło niebieskie; (4). 7-kolorowa stopniowa zmiana oświetlenia; (5). 7-kolorowa nagła zmiana oświetlenia;
-  3 poziomy jasności: 35%--68%--100%
-  Oświetlenie nocne

### II. Sterowanie muzyką

1: Włącz przełącznik zasilania (przełącznik zasilania sieciowego) zainstalowanej lampy sufitowej. Zaświeci się światło ciepłe lampy sufitowej (światło ciepłe).

## 2: Parowanie przez Bluetooth

(1). Przejdź do interfejsu ustawień smartfona.

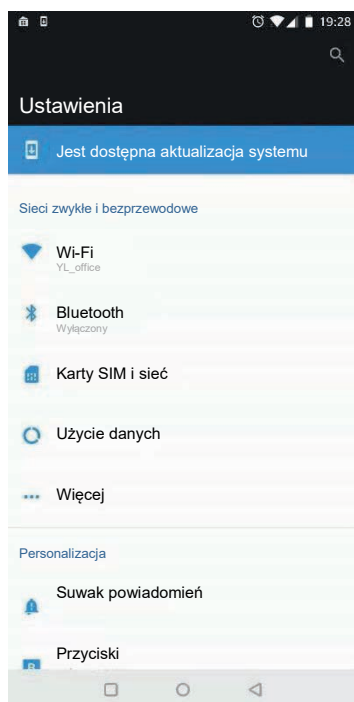

(2). Kliknij pozycję Bluetooth, aby włączyć funkcję Bluetooth na telefonie.

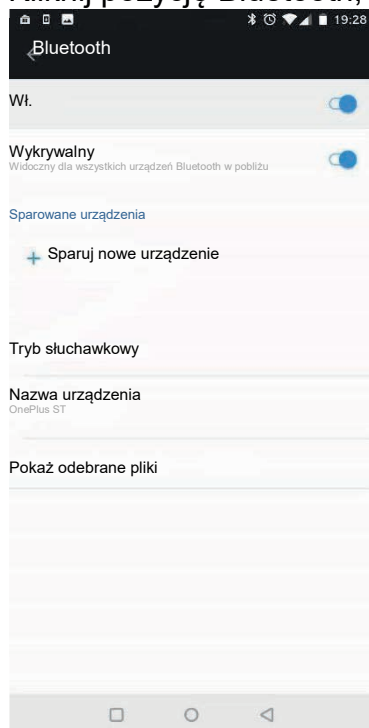

- (3). Kliknij opcję parowania nowego urządzenia. Smartfon zacznie szukać nowego urządzenia Bluetooth w zasięgu. Po wyszukaniu urządzenia „BSD-BT” kliknij opcję parowania. Gdy usłyszysz dźwięk, parowanie zakończyło się pomyślnie.

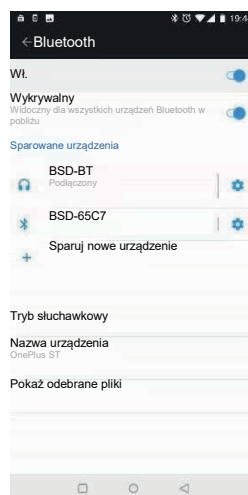
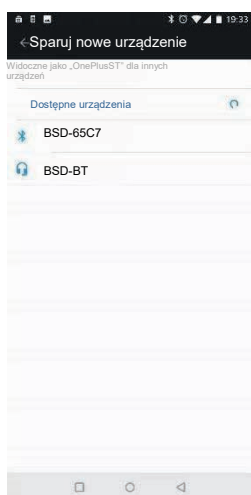

- 3: Po pomyślnym sparowaniu włącz odtwarzacz muzyki na telefonie komórkowym, aby odtworzyć muzykę. Podczas odtwarzania muzyki pilota zdalnego sterowania można używać do sterowania za pomocą funkcji Bluetooth. Obsługa:



Zwiększenie głośności



Zmniejszenie głośności



Poprzedni utwór



Następny utwór



Odtwórz/Wstrzymaj; ten przycisk działa, gdy nawiązano połączenie Bluetooth między smartfonem a lampą z funkcją muzyki.



Aktywacja funkcji regulacji światła (tylko po uprzednim naciśnięciu tego klawisza muzyką można sterować za pomocą przycisków zwiększania/zmniejszania głośności, Poprzedni utwór i Następny utwór na

środkowym przycisku nawigacji)



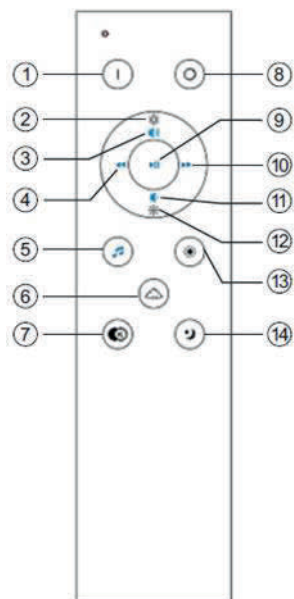









1. Ligar (apenas para luz quente), com função de memorização
2. Brilho + após ser ativada
3. Volume +
4. Música anterior
5. Botão de ativação da função Bluetooth
6. Controlo RGB
7. Controlo de brilho para três níveis diferentes
8. Desligar
9. Ligar/Desligar
10. Próxima música
11. Volume -
12. Brilho - , após ser ativado
13. Botão de ativação para o controlo de brilho (apenas para luz quente)
14. Luz noturna

## Instruções:

### I. Controlo da iluminação

1: Ligue o interruptor (interruptor da alimentação AC) da luz de teto instalada e a luz quente do dispositivo irá acender (luz quente).

2: Nesse momento, pode utilizar o controlo remoto para ajustar o brilho da luz principal (luz quente) e a cor do RGB. A operação é a seguinte:

-  Liga a luz quente, recorda o brilho de quando a lâmpada foi desligada da última vez, as luzes noturna e RGB não possuem função de memorização
-  Desliga a lâmpada (luz quente e RGB ambas desligadas)
-  Aumentar o brilho, aumenta o brilho da luz quente
-  Diminuir o brilho, diminui o brilho da luz quente
-  Ativa a função de controlo da lâmpada (apenas quando esta tecla for pressionada primeiro, pode usar o aumento e diminuição de brilho na tecla de navegação do meio  para ajustar o brilho da luz quente;)
-  Seleção de modo RGB. 5 modos: (1). Luz vermelha; (2). Luz verde; (3). Luz azul; (4). Mudança gradual de iluminação em 7 cores; (5). Mudança repentina de iluminação em 7 cores;
-  3 níveis de brilho, 35%--68%---100%
-  Luz noturna

### II. Controlo de música

1: Ligue o interruptor (interruptor da alimentação AC) da lâmpada de teto instalada, e a luz quente da lâmpada de teto acenderá. (luz quente)



## 2: Emparelhar o Bluetooth

(1). Aceda à interface de configurações do smartphone.



(2). Clique em Bluetooth para ativar a função Bluetooth do seu telefone.

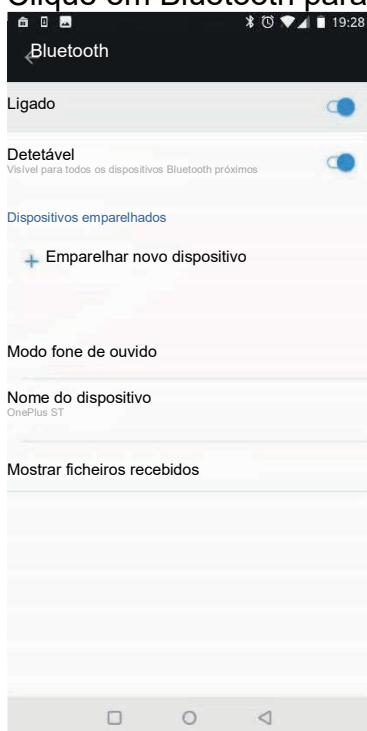

- (3). Clique em emparelhar novo dispositivo; o smartphone inicia a procura por um novo dispositivo Bluetooth dentro do seu alcance. A procurar por “BSD-BT”, clique para emparelhar. Quando ouvir um sinal sonoro, o emparelhamento foi bem sucedido.

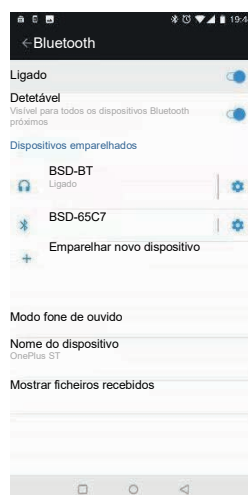
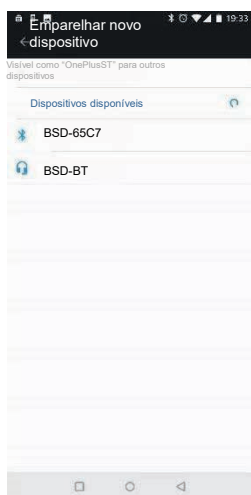

- 3: Após ter emparelhado, abra o reproduzidor de músicas no telemóvel para reproduzir a música. Enquanto estiverem a ser reproduzidas músicas, o controlo remoto pode ser utilizado para controlar o Bluetooth. A operação é a seguinte:



Volume +



Volume -



Música anterior



Próxima música



Reproduzir/Pausar; esta tecla funciona quando as luzes do Bluetooth em ligação com o smartphone e da música estão ativas.



Ativa a função de controlo da iluminação, (apenas quando esta tecla for pressionada primeiro, pode usar as teclas Volume + , Volume - , Música

anterior e Próxima música na tecla de navegação do meio  para mudar a música.

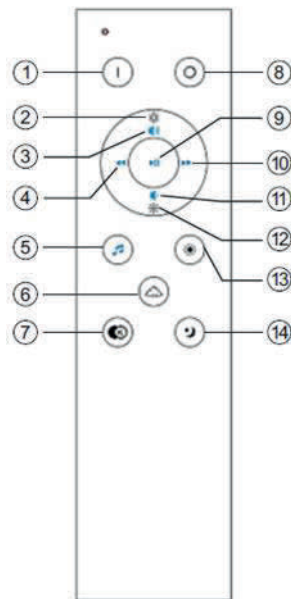









- 29. Aprindere (numai pentru lumină caldă), cu funcție de memorie
- 30. Luminozitate +, după ce a fost activată
- 31. Volum +
- 32. Melodia anterioară
- 33. Buton de activare pentru funcția Bluetooth
- 34. Control RGB
- 35. Control luminozitate pentru trei niveluri diferite
- 36. Oprire
- 37. Pornit/oprit
- 38. Melodia următoarea
- 39. Volum -
- 40. Luminozitate -, după ce a fost activată
- 41. Buton de activare pentru controlul luminozității (numai pentru lumină caldă)
- 42. Lumină de noapte

## Instrucțiuni:

### I. Controlul iluminării

1: Porniți întrerupătorul de rețea (întrerupător de rețea c.a.) al plafonierei instalate și lumina caldă a acesteia se va aprinde (lumină caldă).

2: În acest moment puteți folosi telecomanda pentru a regla luminozitatea luminii principale (lumină caldă) și culoarea RGB. Operarea este următoarea:

-  Aprindere lumina caldă, lampa reține luminozitatea când lumina a fost stinsă ultima dată, RGB și lumina de noapte nu au funcție de memorie
-  Stingere lumină (lumina caldă și lumina RGB, ambele stinse)
-  Reglare luminozitate în sus, crește luminozitatea luminii calde
-  Reglare luminozitate în jos, scade luminozitatea luminii calde
-  Activare funcție control lumină (numai când apăsați acest buton mai întâi, puteți folosi reglarea luminozității în sus și reglarea luminozității în jos de pe butonul central de navigare  pentru a regla luminozitatea luminii calde);
-  Comutare mod RGB. 5 moduri: (1). Lumină roșie; (2). Lumină verde; (3). Lumină albastră; (4). Schimbare gradată lumină cu 7 culori; (5). Schimbare bruscă lumină cu 7 culori;
-  Luminozitate pe 3 niveluri, 35%--68%---100%
-  Lumină de noapte

### II. Controlul muzicii

1: Porniți întrerupătorul de rețea (întrerupător de rețea c.a.) al plafonierei instalate, iar lumina caldă a acesteia se va aprinde (lumină caldă).

## 2: Împerecheați dispozitivul Bluetooth

(1). Accesați interfața setărilor smartphone-ului.

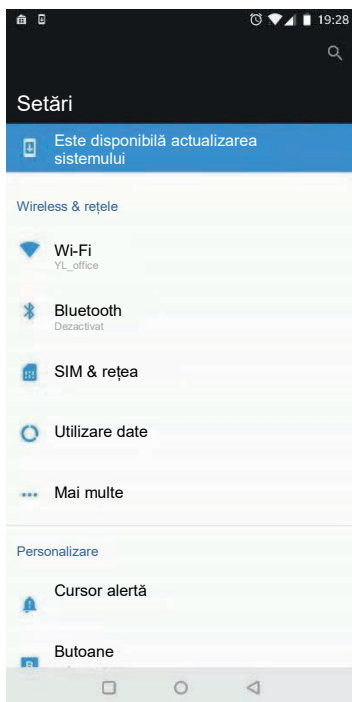

(2). Faceți clic pe Bluetooth pentru a porni funcția Bluetooth a telefonului dvs.

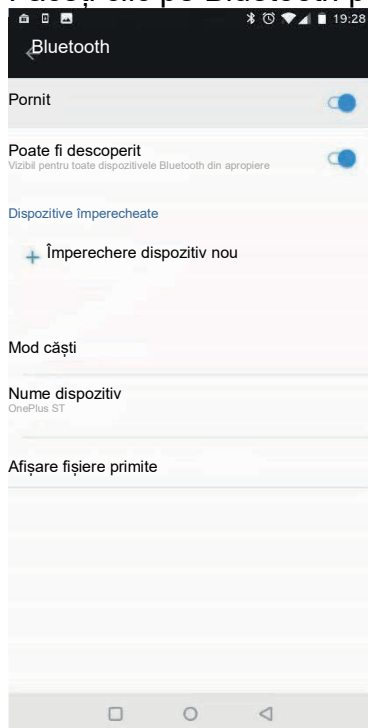

- (3). Faceți clic pe împerechere dispozitiv nou; smartphone-ul începe căutarea unui dispozitiv Bluetooth nou în zonă. Căutare „BSD-BT”, faceți clic pentru împerechere. Când auziți un bip, împerecherea a reușit.

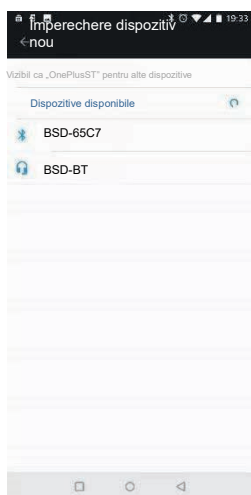

- 3: După ce s-a realizat împerecherea, deschideți player-ul de muzică în telefonul mobil pentru a reda muzică. Când se redă muzică, telecomanda poate fi folosită pentru a controla funcția Bluetooth. Operarea este următoarea:



Volum +



Volum -



Melodia anterioară



Melodia următoare



Play/Pauză; acest buton funcționează când conectarea prin Bluetooth cu smartphone-ul și luminile pentru muzică a reușit .



Activare funcție control lumină, (numai când apăsați mai întâi acest buton, puteți folosi Volum + , Volum - , Melodia anterioară și Melodia următoare

de pe butonul central de navigare  pentru a schimba melodia.

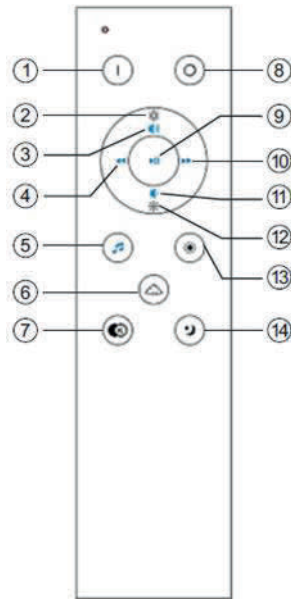









1. Turn on (only for warm light), with memory function
2. Brightness + after being activated
3. Volume +
4. Previous song
5. Activate button for Bluetooth function
6. RGB control
7. Brightness control for three different levels
8. Turn off
9. On/Off
10. Next song
11. Volume -
12. Brightness - , after being activated
13. Activate button for brightness control (only for warm light)
14. Night light

## Instructions:

### I. Lighting control

1: Turn on the power switch (AC power switch) of the installed ceiling light, and the warm light of the ceiling light will light up (warm light).

2: At this time, you can use the remote control to adjust the brightness of the main light (warm light) and the colour of the RGB. The operation is as follows:

-  Turn on the warm light, remember the brightness when the light was turned off last time, RGB and night light have no memory function
-  Turn off the light (warm light and RGB light both off)
-  Dim up, increase the brightness of the warm light
-  Dim down, decrease the brightness of the warm light
-  Activate the light control function (only when you press this key first, you can use the dim up and dim down on the middle navigation key to adjust  the brightness of the warm light;)
-  RGB mode switching. 5 modes: (1). Red light; (2). Green light; (3). Blue light; (4). 7-colour light gradual change; (5).7-colour light sudden change
-  3-level brightness, 35%--68%---100%
-  Night light

### II. Music control

1: Turn on the power switch (AC power switch) of the installed ceiling light, and the warm light of the ceiling light will light up. (warm light)

## 2: Pair the Bluetooth

(1). Enter the smart phone's settings interface.

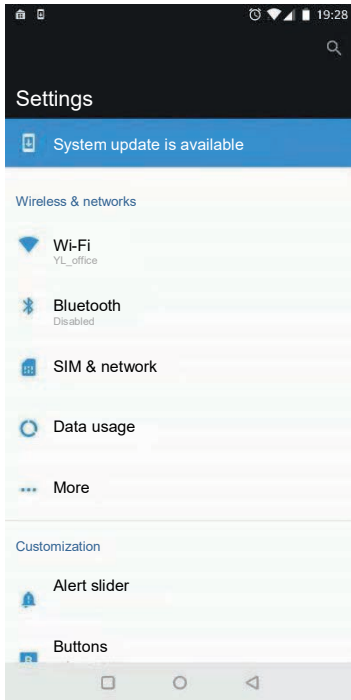

(2). Click Bluetooth to turn on the Bluetooth function of your phone.

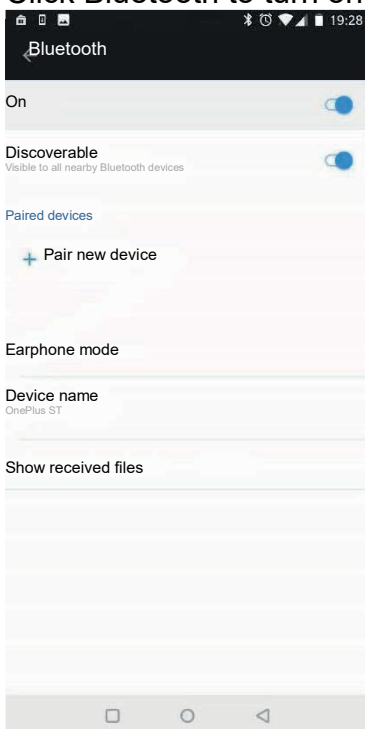

(3). Click pairing the new device; the smart phone starts to search for a new Bluetooth device in range. Searching for “BSD-BT”, click to pair. When you hear a beep tone, the pairing is successful.

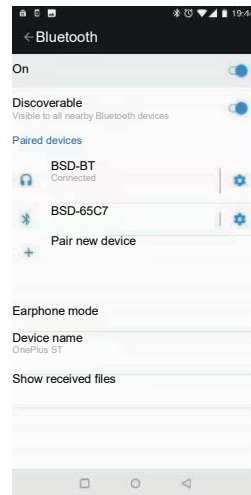
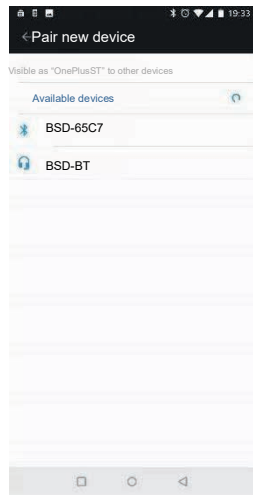
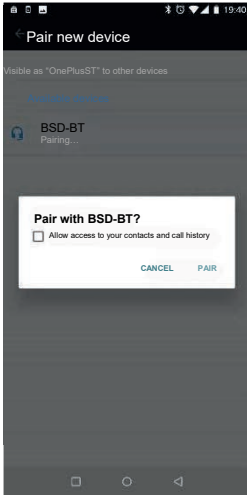

3: After the pairing is successful, open the music player in the mobile phone to play the music. While playing music the remote control can be used to control the Bluetooth. Operation as follow:



 Volume +

 Volume -

 Previous song

 Next song

 Play/Pause; this key works when the Bluetooth connecting with the smart phone and music lights is successful.

 Activate the light control function ,(only when you press this key first, you can use the Volume + , Volume - , Previous song and Next song on the middle navigation key  to change the music.



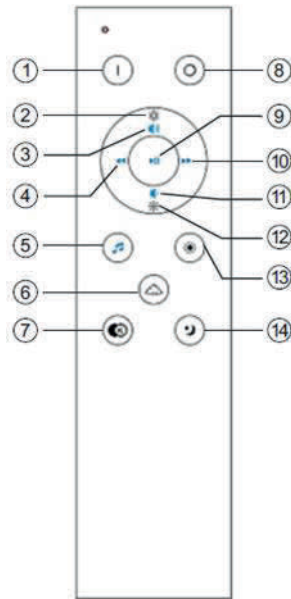









1. Zapnúť (len pre teplé svetlo) s pamäťovou funkciou
2. Jas + po aktivácii
3. Hlasitosť +
4. Predchádzajúca skladba
5. Aktivujte tlačidlo pre funkciu Bluetooth
6. Ovládanie RGB
7. Ovládanie jasu pre tri rôzne úrovne
8. Vypnúť
9. Zap/Vyp
10. Ďalšia skladba
11. Hlasitosť -
12. Jas - po aktivácii
13. Aktivujte tlačidlo pre ovládanie jasu (len pre teplé svetlo)
14. Nočné svetlo

## Pokyny:

### V. Ovládanie osvetlenia

1: Zapnite vypínač (vypínač striedavého napätia) namontovaného stropného svietidla a rozsvieti sa teplé svetlo stropného svietidla (teplé svetlo).

2: Teraz môžete diaľkové ovládanie použiť na úpravu jasu hlavného svetla (teplé svetlo) a farby RGB. Postup je nasledovný:

-  Zapnite teplé svetlo a zapamätajte si jas pri poslednom vypnutí svetla. RGB a nočné svetlo nemajú pamäť.
-  Vypnite svetlo (vypnuté teplé svetlo aj svetlo RGB).
-  Rozsvieťte, zvýšte jas teplého svetla.
-  Stlmte, znížte jas teplého svetla.
-  Aktivujte funkciu ovládania svetla (len ak najprv stlačíte tento kláves, môžete použiť rozsvietenie a stlmenie na strednom navigačnom klávese na úpravu  jasu teplého svetla).
-  Prepínanie režimov RGB 5 režimy: (1). Červené svetlo (2). Zelené svetlo (3). Modré svetlo (4). Postupná zmena 7 farieb svetla. (5). Náhla zmena 7 farieb svetla.
-  3 úrovne jasu: 35 % -- 68 % --- 100 %.
-  Nočné svetlo.

### VI. Ovládanie hudby

1: Zapnite vypínač (vypínač striedavého napätia) namontovaného stropného svietidla a rozsvieti sa teplé svetlo stropného svietidla. (teplé svetlo)

## 2: Spárovanie Bluetooth

(1). Zadajte rozhranie nastavení smartfónu.

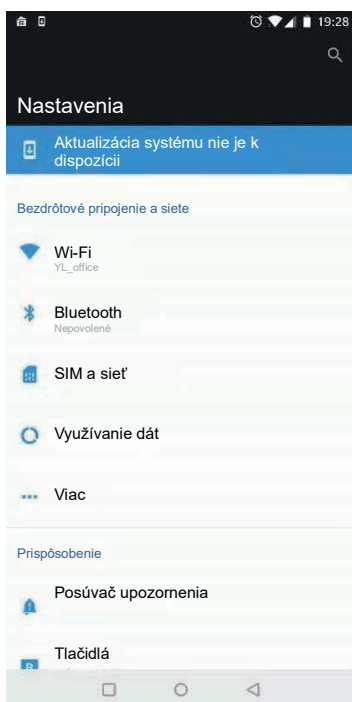

(2). Funkciu Bluetooth svojho telefónu zapnete kliknutím na Bluetooth.

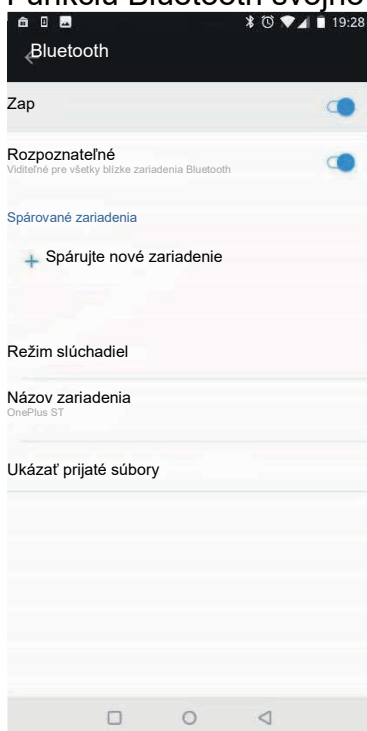

- (3). Kliknite na párovanie nového zariadenia. Smartfón začne vyhľadávať nové Bluetooth zariadenie v dosahu. Pre vyhľadávanie „BSD-BT“ kliknite na párovanie. Ak budete počuť pípnutie, párovanie bolo úspešné.

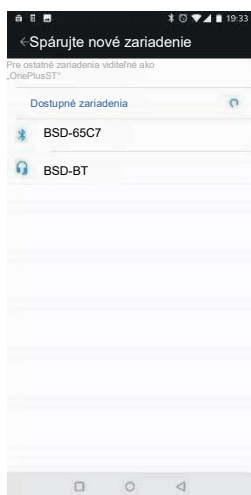

- 3: Po úspešnom spárovaní si v mobilnom telefóne otvorte prehrávač hudby a môžete si púšťať hudbu. Pri prehrávaní hudby sa diaľkové ovládanie môže použiť na ovládanie Bluetooth. Postup je nasledovný:



 Hlasitosť +

 Hlasitosť -

 Predchádzajúca skladba

 Ďalšia skladba

 Play/Pause: tieto klávesy fungujú po úspešnom pripojení Bluetooth smartfónu a hudobných svetiel.

 Aktivujte funkciu ovládania svetla (len ak najprv stlačíte tento kláves, môžete na zmenu hudby použiť Volume + a Volume - , Predchádzajúca skladba a ďalšia skladba na strednom navigačnom klávese ).

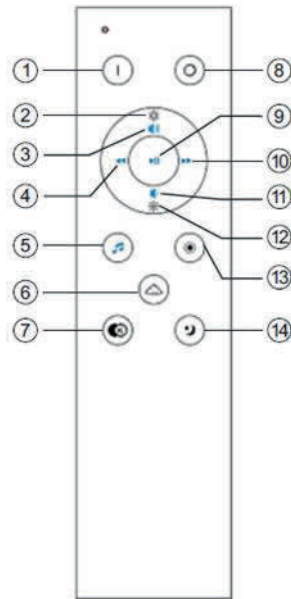









- 43. Vklp (samo za toplo lučko) s funkcijo spomina
- 44. Svetlost + po vklopu
- 45. Glasnost +
- 46. Prejšnja skladba
- 47. Gumb za vklop funkcije Bluetooth
- 48. RGB nadzor
- 49. Nadzor glasnosti za tri različne nivoje
- 50. Izklp
- 51. Vklp/Izklp
- 52. Naslednja skladba
- 53. Glasnost -
- 54. Svetlost – po vklopu
- 55. Gumb za vklop nadzora svetlosti (samo za toplo lučko)
- 56. Nočna lučka

## Navodila:

### I. Nadzor nad svetilko

1: Vklpote stikalo za vklop (stikalo za napajanje) nameščene stropne svetilke in le-ta bo zasvetila v topli luči (topla lučka).

2: V tem trenutku lahko z daljinskim upravljalnikom prilagodite svetlost glavne lučke (topla lučka) in barvo RGB lučke. Izvede se, kot sledi:

-  Vklpote toplo lučko, zapomnite si svetlost, pri kateri ste lučko nazadnje izklopili, RGB in nočna lučka nimata funkcije pomnjenja
-  Izklopote lučko (tako toplo kot RGB lučko)
-  Zatemnite, povečajte svetlost tople lučke
-  Odtemnite, zmanjšajte svetlost tople lučke
-  Vklpote funkcijo za nadzor lučke (samo takrat, kadar najprej pritisnete to tipko, lahko uporabite zatemnitev in odtemnitev na osrednji navigacijski tipki, da prilagodite  svetlost tople lučke;)
-  Preklop med RGB načini. 5 načini: (1). Rdeča lučka; (2). Zelena lučka; (3). Modra lučka; (4). postopno spreminjanje 7 barv; (5). nenadno spreminjanje 7 barv
-  svetlost v 3 stopnjah, 35%--68%---100%
-  Nočna lučka

### II. Nadzor nad glasbo

1: Vklpote stikalo za vklop (stikalo za napajanje) nameščene stropne svetilke in le-ta bo zasvetila v topli luči (topla lučka).

## 2: Seznanite Bluetooth

(1). Vstopite v vmesnik z nastavitvami pametnega telefona.

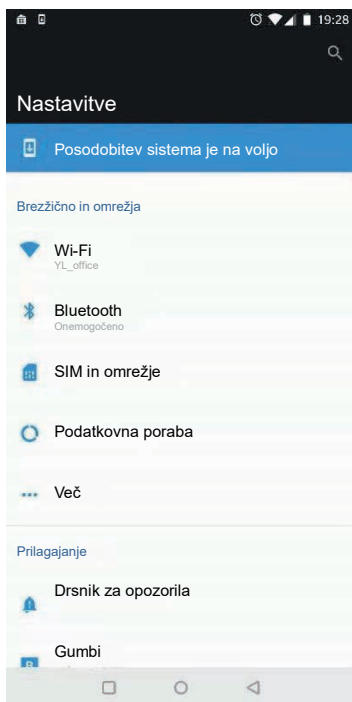



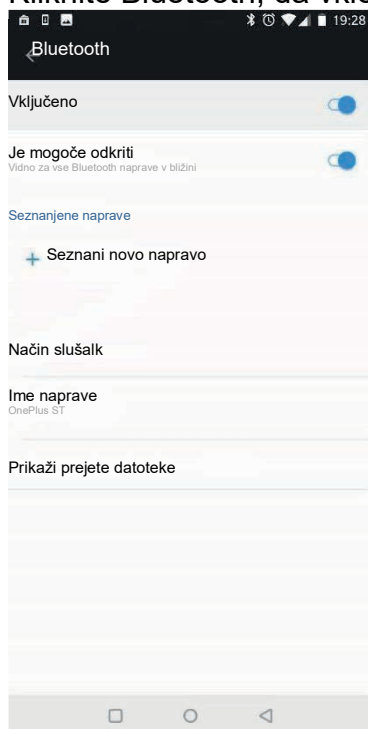

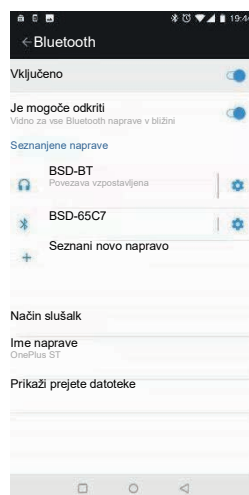
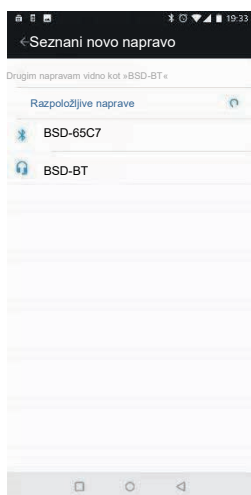

(2). Kliknite Bluetooth, da vklopite Bluetooth funkcijo svojega telefona.



- (3). Kliknite seznanitev nove naprave; pametni telefon začne iskati novo Bluetooth napravo v dosegu. Iskanje »BSD-BT«, kliknite za seznanitev. Ko zaslišite pisk, je bila seznanitev uspešna.



- 3: Po uspešni seznanitvi odprite predvajalnik glasbe na mobilnem telefonu ter predvajajte glasbo. Pri predvajanju glasbe lahko daljinski upravljalnik uporabljate za nadzor nad Bluetoothom. Upravljate ga, kot sledi:

-  Glasnost +
  -  Glasnost -
  -  Prejšnja skladba
  -  Naslednja skladba
  -  Predvajaj/Ustavi; ta tipka deluje, kadar je Bluetooth povezava s pametnim telefonom uspešno vzpostavljena.
  -  Vklopite funkcijo za nadzor lučke (samo takrat, kadar najprej pritisnete to tipko, lahko uporabljate Glasnost + , Glasnost - , Prejšnja skladba in
- Naslednja skladba na osrednji navigacijski tipki  za menjavo glasbe.

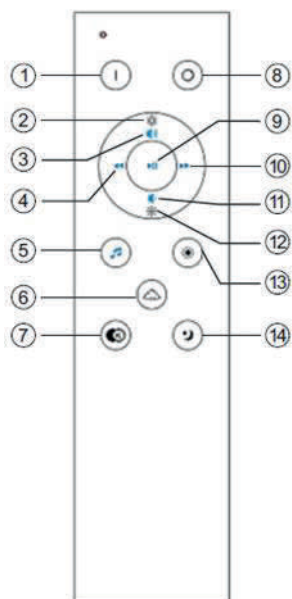









1. Sätt på (enbart för varmt ljus), med minnesfunktion
2. Ljusstyrka + efter aktivering
3. Volym +
4. Föregående låt
5. Aktiveringsknapp för Bluetooth-funktion
6. RGB-kontroll
7. Kontroll för ljusstyrka med tre olika nivåer
8. Stäng av
9. På/Av
10. Nästa låt
11. Volym -
12. Ljusstyrka -, efter aktivering
13. Aktiveringsknapp för ljusstyrka (enbart för varmt ljus)
14. Nattbelysning

## Instruktioner:

### I. Ljuskontroll

1: Slå på strömbrytaren (växelströmsbrytaren) på den installerade taklampan, och taklampans varma ljus kommer att tändas (varmt ljus).

2: Nu kan du använda fjärrkontrollen för att justera ljusstyrkan på huvudlampan (varmt ljus) och färgen på RGB. Så här gör du:

-  Tänd det varma ljuset. Kom ihåg ljusstyrkan när det släcktes förra gången. RGB och nattbelysning har ingen minnesfunktion
-  Släck ljuset (både varmt ljus och RGB-ljus släcks)
-  Dimma upp, öka ljusstyrkan på det varma ljuset
-  Dimma ned, dämpa ljusstyrkan på det varma ljuset
-  Aktivera ljuskontrollfunktionen (enbart när du trycker på denna knapp först kan du öka och dämpa ljusstyrkan med navigationsknappen i mitten för att justera  det varma ljusets ljusstyrka.
-  Ändra RGB-läge. 5 lägen: (1). Rött ljus; (2). Grönt ljus; (3). Blått ljus; (4). Gradvis övergång mellan 7 färger; (5). Plötslig övergång mellan 7 färger
-  Ljusstyrka med 3 nivåer, 35 %–68 %–100 %
-  Nattbelysning

### II. Musikkontroll

1: Slå på strömbrytaren (växelströmsbrytaren) på den installerade taklampan, och taklampans varma ljus kommer att lysa. (varmt ljus).

## 2: Parkoppla Bluetooth

(1). Gå till smartmobilens inställningsskärm.

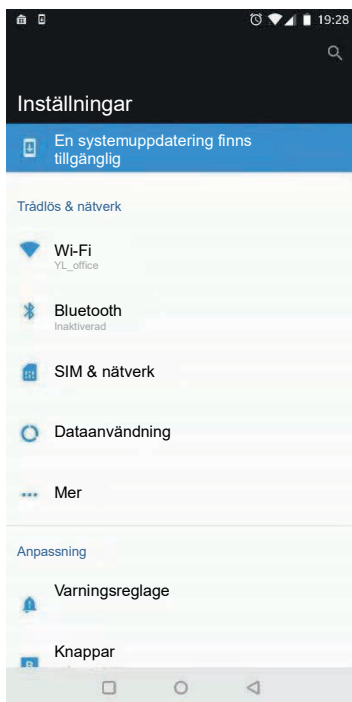

(2). Klicka på Bluetooth för att sätta på Bluetooth-funktionen på din telefon.





- (3). Klicka på parkoppla för den nya enheten; smartmobilen kommer att börja söka efter en ny Bluetooth-enhet i närheten. Sök efter "BSD-BT", klicka för att ansluta. När du hör ett pip ljud har parkopplingen lyckats.

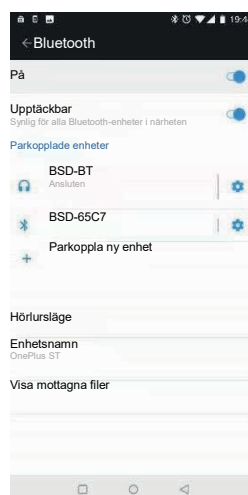
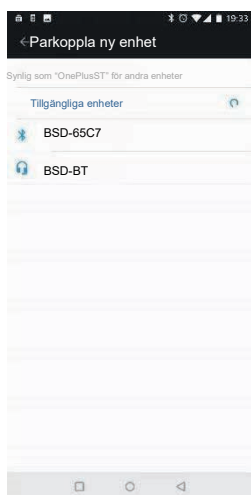

- 3: Efter att parkopplingen har lyckats, öppna musikspelaren i mobiltelefonen för att spela musik. När musik spelas kan fjärrkontrollen användas för att kontrollera Bluetooth. Så här gör du:

 Volym +

 Volym -

 Föregående låt

 Nästa låt

 Spela/Pausa; denna knapp fungerar när Bluetooth-anslutningen mellan smartmobilen och musikljustet har lyckats.

 Aktivera ljuskontrollfunktionen. Enbart när du trycker på denna knapp först kan du använda Volym + , Volym - , Föregående låt och Nästa låt på

navigationssknappen i mitten  för att ändra musiken.

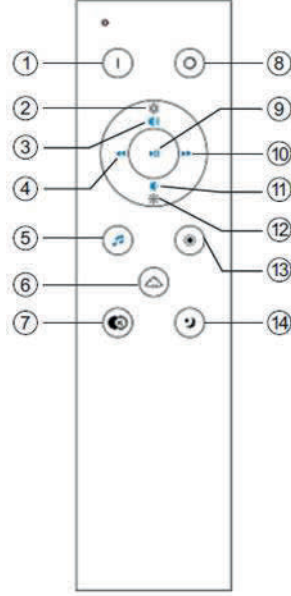









- 57. Aç (sadece sıcak ışık için), bellek işlevi vardır
- 58. Etkinleştirildikten sonra parlaklık +
- 59. Ses +
- 60. Önceki şarkı
- 61. Bluetooth işlevi etkinleştirme düğmesi
- 62. KYM (RGB) düğmesi
- 63. Üç farklı düzey için parlaklık ayarı
- 64. Kapat
- 65. Aç/Kapat
- 66. Sıradaki şarkı
- 67. Ses -
- 68. Etkinleştirildikten sonra parlaklık -
- 69. Parlaklık ayarı etkinleştirme düğmesi (sadece sıcak ışık için)
- 70. Gece lambası

## Talimatlar:

### I. Aydınlatma ayarı

1: Takılan tavan lambasının güç anahtarını (AC güç düğmesi) açın, tavan lambasının sıcak ışığı yanacaktır (sıcak ışık).

2: Şu anda ana ışık (sıcak ışık) parlaklığı ve KYM/RGB renk parlaklığını ayarlamak için uzaktan kumandayı kullanabilirsiniz. İşlem şöyledir:

-  Sıcak ışığı açın, ışığın en son kapatılma anındaki parlaklığı hatırlayın, KYM/RGB ve gece lambasının bellek işlevi yoktur
-  Işığı kapatın (hem sıcak ışık hem de KYM/RGB ışığı kapanır)
-  Aydınlaştırın, sıcak ışığın parlaklığını artırın
-  Loşlaştırın, sıcak ışığın parlaklığını azaltın
-  Işık ayar işlevini etkinleştirin (sadece önce bu düğmeye bastığınızda sıcak ışık parlaklığını ayarlayan göbekteki komut düğmesi üzerinde  aydınlık ve loşluk ayarlarını kullanabilirsiniz;)
-  KYM/RGB seçenek düğmesi. 5 seçenek: (1). Kırmızı ışık; (2). Yeşil ışık; (3). Mavi ışık; (4). Kademeli değişen 7 renkli ışık; (5). Ani değişen 7 renkli ışık
-  3 parlaklık düzeyi, %35--%68---%100
-  Gece lambası

### II. Müzik ayarı

1: Takılan tavan lambasının güç düğmesini (AC güç düğmesi) açın; tavan lambasının sıcak ışığı yanacaktır. (sıcak ışık)

## 2: Bluetooth'u eşleştirin

(1). Akıllı telefonun ayar arayüzüne girin.

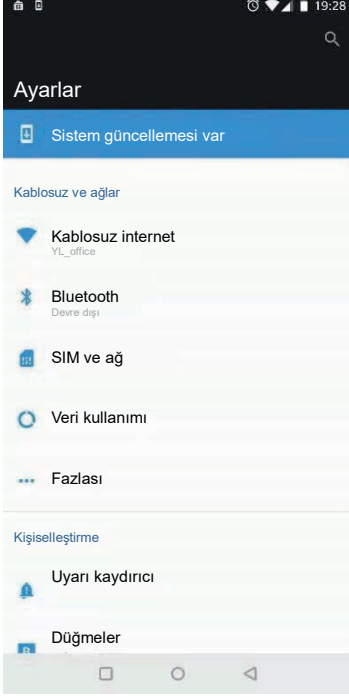

(2). Telefonunuzun Bluetooth işlevini açmak için Bluetooth'u tıklayın.



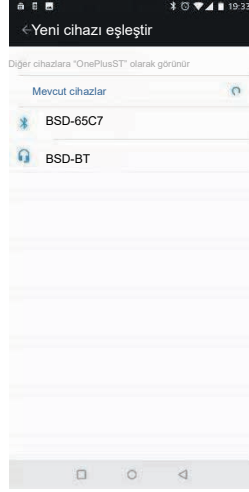

(3). Yeni cihazı eşleştirmeyi tıklayın; akıllı telefon, kapsama alanında yeni bir Bluetooth cihazı aramaya başlar. "BSD-BT" aranıyor, eşleştirmek için tıklayın. Bir bip sesi duyduğunuzda, eşleştirme başarılıdır.



3: Eşleştirme başarılı olduktan sonra müziği çalmak için cep telefonundaki müzik çaları açın. Müzik çalarken Bluetooth'u kumanda etmek için uzaktan kumanda kullanılabilir. İşlem şöyledir:

 Ses +

 Ses -

 Önceki şarkı

 Sıradaki şarkı

 Oynat/Durdur; Bluetooth akıllı telefona ve müzik ışıklarına bağlanmada başarılı olduğunda bu düğme çalışır.

 Işık ayar işlevini etkinleştirin (sadece önce bu düğmeye bastığınızda müziği ayarlayan göbekteki komut düğmesi üzerinde Ses + , Ses - , Önceki şarkı

ve Sıradaki şarkı ayarlarını  kullanabilirsiniz.